



The Utah-400 Digital Routing Switcher

144x144 Systems



System Setup and Operation

The Utah-400/144x144 Digital Routing Switcher Operators' Manual

- Document Number: 82101-0070
- Document Version: 2.1.2
- Date: July 1, 2010
- Printed in U.S.A.

Copyrights and Trademarks

© 2010 Utah Scientific, Inc., All rights reserved. Any use or reproduction of this guide's contents without the prior written consent of Utah Scientific, Inc. is strictly prohibited.

Utah-400 is a trademark of Utah Scientific, Inc.

Windows, Windows 2000 and Windows NT are registered trademarks of Microsoft Corporation.

All other product names and any registered or unregistered trademarks mentioned in this guide are used for identification purposes only and remain the exclusive property of their respective owners.

Notice

Information contained in this guide is subject to change without notice or obligation. While every effort has been made to ensure that the information is accurate as of the publication date, Utah Scientific, Inc. assumes no liability for errors or omissions. In addition, Utah Scientific, Inc. assumes no responsibility for damages resulting from the use of this guide.

FCC Compliance (USA) and Digital Equipment Compliance (Canada)

This equipment has been tested and found to comply with the limits for a Class A, digital device, pursuant to Part 15, Subpart B of the FCC Rules and the Canadian EMC Requirement (ICES-003). These limits are designed to provide reasonable protection against harmful interference when the equipment is operated in a commercial environment. This equipment generates, uses, and can radiate radio frequency energy and, if not installed and used in accordance with the instruction manual, may cause harmful interference to radio communications. Operation of this equipment in a residential area is likely to cause harmful interference, in which case, the user will be required to correct the interference at their own expense. Shielded cables must be used to ensure compliance with the FCC Class A limits.

Declaration of Conformity

Utah Scientific, Inc.

4750 Wiley Post Way, Suite 150
Salt Lake City, Utah 84116-2878 U.S.A.

We declare our sole responsibility that the Utah-400 Digital Routing Switcher is in conformance with the following standards:

Emission

- EN55022:1994+A1&A2

Immunity

- EN55024:1998
- EN61000-3-2
- EN61000-3-3

Safety

- IEC 60950-1:2001 /EN 60950-1:2001

Following the provisions of the Directive(s) of the Council of the European Union:

- EMC Directive 89/336/EED
- Low Voltage Electrical Directive 72/23/EEC

Utah Scientific, Inc. hereby declares that the product specified above conforms to the above Directive(s) and Standard(s).



Important Safeguards and Notices

This section provides important safety guidelines for the Operator and Service Personnel. Specific warnings and cautions are found throughout the guide where they apply, but may not appear here. Please read and follow the important safety information, specifically those instructions related to risk of fire, electric shock, or injury to persons.

Safety Symbols



- Hazardous Voltage symbol



- Caution symbol. The product is marked with this symbol when it is necessary to refer to the manual to prevent damage to the product.

Warnings

Please observe the following important warnings:



- Any instructions in this guide that require opening the chassis, changing a power supply, or removing a board, should be performed by qualified personnel only. To reduce the risk of electric shock, do not perform any service unless you are qualified to do so.
- Heed all warnings on the unit and in the operating instructions.
- Do not use this product in or near water. Disconnect AC power before installing any options or servicing the unit unless instructed to do so by this manual.
- This product is grounded through the power cord ground conductor. To avoid electric shock, plug the power cord into a properly wired receptacle before connecting the product inputs or outputs.
- Route power cords and other cables so they won't be damaged.
- The AC receptacle (socket) should be located near the equipment and be easily accessible.
- Disconnect power before cleaning. Do not use any liquid or aerosol cleaner - use only a damp cloth.



- Dangerous voltages exist at several points in this product. To avoid personal injury, do not touch exposed conductors and components while power is on. Do not insert anything into either of the systems two-power supply cavities with power connected.
- Do not wear hand jewelry or watches when troubleshooting high current circuits, such as power supplies. During installation, do not use the door handles or front panels to lift the equipment as they may open abruptly and injure you.
- To avoid fire hazard when replacing fuses, use only the specified correct type, voltage and current rating as referenced in the appropriate parts list for this product. Always refer fuse replacement to qualified service personnel.
- Have qualified personnel perform safety checks after any service.

Cautions

Please observe the following important cautions:



- When installing this equipment do not install power cords to building surfaces. To prevent damage when replacing fuses, locate and correct the problem that caused the fuse to blow, before reconnecting power.
- Use only specified replacement parts

Notices

Please observe the following important notes:



- When the adjacent symbol is indicated on the chassis, please refer to the manual for additional information.
- For the HD-2020 Chassis and Master Control Panel, refer to “Connecting and Disconnecting Power” - Chapter 2 (Hardware Installation).

Company Information

Utah Scientific, Incorporated

**4750 Wiley Post Way, Suite 150
Salt Lake City, Utah 84116-2878 U.S.A.**

- Telephone: +1 (801) 575-8801
- FAX: +1 (801) 537-3098
- Technical Services (voice): +1 (800) 447-7204
- Technical Services (FAX): +1 (801) 537-3069
- E-Mail -General Information: info@utsci.com
- E-Mail -Technical Services: service@utsci.com
- World Wide Web: <http://www.utahscientific.com>
- **After Hours Emergency:** +1 (800) 447-7204. Follow the menu instructions for Emergency Service.

Warranty Policies

Hardware Warranty

Utah Scientific, Inc. warrants to the original purchaser that the Utah Scientific hardware is free from defects in materials and workmanship and will perform substantially in accordance with the accompanying written materials under normal use and service for a period of ten (10) years from the date of shipment. Any implied warranties on hardware are limited to ten (10) years. Some states/jurisdictions do not allow limitations on duration of an implied warranty, so the above limitation may not apply to certain specific purchasers.

Software Warranty

Utah Scientific warrants that the software will perform substantially in accordance with the accompanying written materials for a period of one (1) year from the date of shipment.

Customer Remedies

For the first one (1) year after purchase of the software and the first ten (10) years after the date of purchase of the hardware, Utah Scientific's and its suppliers' entire liability and purchaser's exclusive remedy shall be, at Utah Scientific's option, either:

- Return of the price paid, or
- Repair or replacement of the software or hardware that does not meet the above warranties and is returned to Utah Scientific under the returned materials authorization (RMA) process with freight and forwarding charges paid.

After the initial warranty periods, purchaser's exclusive remedy is the repair or replacement of the hardware upon payment of a fixed fee to cover handling and service costs based on Utah Scientific's then-current price schedule. The above warranties are void if failure of the software or hardware has resulted from an accident, abuse, or misapplication. Any replacement software or hardware will be warranted for the remainder of the original warranty period or thirty (30) days, whichever is longer.

No other warranties. To the maximum extent permitted by applicable law, Utah Scientific and its suppliers disclaim all other warranties, either express or implied, including, but not limited to implied warranties of merchantability and fitness for a particular purpose, with regard to the software, the accompanying written materials, and any accompanying hardware. This limited warranty gives the purchaser specific legal rights. These rights may vary in certain states/jurisdictions.

No liability for consequential damages. To the maximum extent permitted by applicable law, in no event shall Utah Scientific or its suppliers be liable for any damages whatsoever (including without limitation, damages for loss of business profits, business interruption, loss of business information, or any other pecuniary loss) arising out of the use of or inability to use Utah Scientific products, even if Utah Scientific has been advised of the possibility of such damages. Because some states/jurisdictions do not allow the exclusion or limitation of liability for consequential or incidental damages, the above limitation may not apply in those circumstances.

Table of Contents

**The Utah-400/144x144 Digital Routing Switcher Operators'
Manual**

CHAPTER 1

Introduction

| | |
|---|------|
| In This Guide | 1-1 |
| Conventions | 1-2 |
| Abbreviations | 1-3 |
| Terms | 1-4 |
| Routing Switcher Basics | 1-5 |
| Switching Matrix | 1-6 |
| Signal Levels | 1-7 |
| The Utah-400 Routing Matrix | 1-8 |
| Introducing the Utah-400 Digital Routing Switcher | 1-10 |
| System Configurations | 1-12 |
| Sample Configurations | 1-12 |

CHAPTER 2

Hardware Installation

| | |
|---|------|
| In This Chapter | 2-1 |
| Unpacking and Inspection | 2-2 |
| Installing Physical Equipment | 2-3 |
| Mounting Equipment in Rack Frames | 2-3 |
| Installing the Utah-400 Digital Routing Switcher | 2-3 |
| Installing the MX-Bus Cables | 2-6 |
| Interconnecting the SC-3 and Utah-400 Frames | 2-6 |
| Connecting the AES Reference Signal | 2-8 |
| Determining and Setting Router Signal Levels | 2-9 |
| Video/Unbalanced Digital Audio Input & Output Signals | 2-13 |
| Installing the Analog Audio Input and Output Cables | 2-16 |
| Connecting and Disconnecting Power | 2-21 |
| AC Connectivity | 2-21 |

| | |
|---|------|
| DC Connectivity | 2-22 |
| Crosspoint Board LEDs | 2-23 |
| If no LED's on the Crosspoint board are on: | 2-23 |
| Hardware Checkout | 2-24 |

CHAPTER 3

Configuration and Operation

| | |
|---|-----|
| In This Chapter | 3-1 |
| Utah 400 SC-4 Control | 3-2 |
| Operation | 3-4 |
| Input and Output Card Removal and Replacement | 3-4 |
| Crosspoint Card Removal and Replacement | 3-4 |
| Fan Service | 3-5 |
| Additional Notes (Service) | 3-6 |
| Power Supplies | 3-6 |
| Crosspoint Control (Cards) | 3-8 |
| Power Cord Retainer | 3-9 |

CHAPTER 4

Utah-400 Components

| | |
|---|------|
| In This Chapter | 4-1 |
| Video Input Boards | 4-2 |
| SD Video Input | 4-2 |
| Multi-Rate Input | 4-2 |
| Analog to Digital | 4-3 |
| Reclocking Input Expansion Card | 4-5 |
| UTAH-400 3G Input Card | 4-6 |
| Video Output Boards | 4-8 |
| SD-Output | 4-8 |
| HD-Output (Multi-Rate output card) | 4-9 |
| Digital Video to Analog Converter Output card | 4-9 |
| Multi-Rate Output Board | 4-11 |
| Control Description | 4-13 |
| UTAH-400 3G Output Board | 4-14 |
| Fiber Interface | 4-17 |
| Specification Detail | 4-18 |
| Fiber Output LED Indications | 4-19 |
| Fiber Operation at 3 Gb/Sec. | 4-20 |

| | |
|---|------|
| Video Crosspoint Board (Redundant) | 4-21 |
| User Controls | 4-22 |
| Indicators | 4-22 |
| FPGA Control Board | 4-23 |
| Interface Board (Midplane) | 4-26 |
| Part Description | 4-27 |
| Power Supplies | 4-29 |
| LED Indications | 4-29 |
| Audio Input | 4-30 |
| Audio Input Board | 4-30 |
| Audio Output | 4-31 |
| Audio Output Board | 4-31 |
| Deluxe Output Board | 4-32 |
| Board Indicators | 4-33 |
| Deluxe Output Module | 4-34 |
| DAC Output Module | 4-36 |
| ADC Input Module | 4-38 |
| Audio Crosspoint Board (Single Chassis version) | 4-40 |
| Front Edge Card Indicators (Left Bank) | 4-41 |
| Front Edge Card Indicators (Right Bank) | 4-42 |
| Audio Crosspoint Adjustments | 4-42 |
| Time Base Module | 4-43 |
| Fuses | 4-45 |
| Test points (front of Crosspoint card) | 4-46 |
| Crosspoint Card (Redundant 144 Audio Systems) | 4-47 |
| LED Status - 121120 Board | 4-48 |

CHAPTER 5*Troubleshooting*

| | |
|---|-----|
| In This Chapter | 5-1 |
| Subsystem Level Troubleshooting | 5-2 |
| Main Troubleshooting Chart | 5-2 |
| Video Subsystem Troubleshooting Table | 5-4 |
| Audio Subsystem Troubleshooting Table | 5-5 |
| Power Subsystem Troubleshooting Table | 5-6 |
| Power Supply Alarms | 5-6 |
| Control Subsystem Troubleshooting Table | 5-7 |

| | |
|-------------------------------------|-----|
| System Controller Alarms | 5-8 |
| Control Panel Troubleshooting | 5-9 |
| UNET Panels | 5-9 |
| Ethernet Panels | 5-9 |

APPENDIX A

Specifications

| | |
|--|-----|
| In this Appendix | A-1 |
| Power | A-2 |
| Input Power and DC Power Specifications | A-2 |
| Digital Video | A-3 |
| Digital Audio | A-4 |
| High Definition SDI Video | A-5 |
| Reference | A-5 |
| Control | A-6 |
| Alarms | A-7 |
| Physical | A-8 |
| Regulatory | A-8 |
| Connector Suppliers and USI Part Numbers | A-9 |

APPENDIX B

The Debug Port

| | |
|--|------|
| Utah-400 Firmware | B-2 |
| Version 2.09 Release Notes | B-2 |
| Version 2.08 Release Notes | B-2 |
| Menu Items | B-2 |
| Status | B-3 |
| The Debug Cable | B-3 |
| Using the Debug Port | B-4 |
| Startup Display | B-5 |
| Main Menu Display | B-5 |
| FPGA Memory Status | B-6 |
| Verifying the Software Version | B-6 |
| Checking the Router Crosspoint Status | B-7 |
| Checking Input / Output Card Information | B-10 |
| IO Information – full display | B-11 |

Table of Contents

IO Card Information – Locator Diagram B-12
Hardware Status Display B-13

APPENDIX C

The Utah-400 Digital Audio Breakout Panel

Scope C-2
The AES Breakout Panel Kit C-2
Description of the AES Breakout Panel C-2
Installation of the AES Breakout Panel C-2
Label Instructions for the Utah-400 Breakout Panel C-5
 Scope C-5
 Application C-5

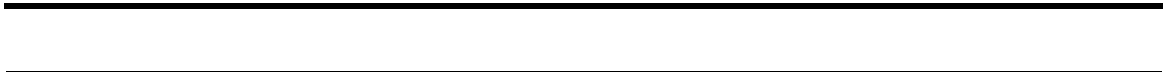

List of Figures

Chapter 1

- Utah-400 (front view) 1-8
- The Utah-400 Matrix Block Diagram 1-9
- The Utah-400 144 x 144 Configuration 1-12
- 144x144 with Redundant Crosspoints 1-13

Chapter 2

- Utah-400 Packaging 2-2
- Utah-400 Chassis Mounted in 19" Rack Frame 2-4
- Sliding the Utah-400 Chassis into Rack Frame 2-5
- Lowering the Utah-400 Chassis on the Rack Screw 2-6
- The MX-Bus Installation to an SC-4 Controller 2-7
- Block Diagram of the MX-Bus Daisy Chain. 2-8
- AES Reference Cabling 2-9
- Crosspoint Carrier Board Dipswitch Location 2-10
- Utah-400 Configuration Dipswitches as they appear on the Crosspoint Carrier Board 2-11
- Utah-400 1442 Video Unbalanced Audio Rear Panels 2-14
- Unbalanced Digital Audio/Digital Video Input Connector Matrix 2-15
- Unbalanced Digital Audio/Digital Video Output Connector Matrix 2-15
- Utah-400 Analog Audio Backplane 2-17
- DB-26 High-Density Male Connector 2-20
- DB-26 High-Density Female Connector 2-20
- Utah-400 Power Connections 2-21
- Crosspoint Fuse Location 2-23

Chapter 3

- Utah 400 SC-4 for Utah-400 and MC/MCP-2020 3-2
- Input/Output Board Replacement and Removal 3-4
- Crosspoint Board Replacement and Removal 3-4
- Fan location 3-5
- Fan Connection 3-5

Chapter 4

- SD Video Input Board 4-2
- Multi-Rate Input Board 4-2
- Analog to Digital Board 4-3
- Power Good LED 4-3
- Analog to Digital card LEDs 4-4
- Reclocking Input Expansion card 4-5
- 3 Gig Input card 4-6
- SD Output Board 4-8
- Multi-Rate Output Board 4-9
- Digital to Analog Output Card 4-9
- Video Output Power Good LED 4-10
- SD/HD Video Output and Digital Video to Analog LED Indicators 4-10
- Module location and removal 4-17
- Input and Output boards 4-17
- SP2T - Transmitter module 4-18
- Video Crosspoint Board (Redundant) 4-21
- Video Crosspoint Dip Switches 4-22
- Video Crosspoint LEDs 4-23
- Video Crosspoint control Module 4-23
- Video crosspoint module jumper location 4-25
- Video Midplane 4-26
- Redundant Midplane 4-26
- Audio Midplane's RJ-45 connection 4-27
- Power Supply 4-29
- Audio Input Card 4-30
- Audio Output Card 4-31
- Deluxe Audio Output Card 4-32
- Deluxe Audio Output Card 4-33
- Deluxe Output Module 4-34
- DAC Output Module 4-36
- ADC Input Module 4-38
- Audio Crosspoint board 4-40
- Audio Time Base Module 4-43
- Crosspoint board fuse assembly 4-45
- Audio Crosspoint board test points 4-46

Appendix B

- Debug Port Cable Pinouts B-3
- Crosspoint display (hex) B-7
- Crosspoint display - Inputs to Outputs B-8
- Crosspoint display - input 00 switched to outputs B-9
- Crosspoint display as decimal matrix B-9
- Display format - I/O card info B-10
- I/O info - Full display B-11
- I/O card information - locator diagram B-12

Appendix C

- Wire Prep C-3
- Tension Clamp Connector (viewed from the back) C-4
- Breakout Panel Label Application C-6

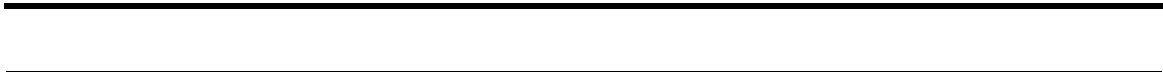

In This Guide

This guide provides instructions on installing, configuring and operating the Utah Scientific, Utah-400 Digital Signal Routing Switcher. The following chapters and appendices are included:

- **Chapter 1**

"Introduction" summarizes the guide, describes basic router operation and describes the hardware and software components of the Utah-400 Digital Routing Switcher.

- **Chapter 2**

"Hardware Installation" provides instructions for installing the Utah-400 Digital Routing Switcher in your facility.

- **Chapter 3**

"Configuration and Operation" provides specific information regarding the configurations of this unit, and necessary equipment handling (operation).

- **Chapter 4**

"Utah-400 Router Components" provides basic information about the Input, Output, Crosspoint, Interface board and Power Supplies. Included is general information about LED indicators and alarms present on each board type.

- **Chapter 5**

"Troubleshooting" looks at some of the common hardware and software problems, diagnostics and solutions available to the user on site. Included in this section is information on the various avenues to contact Utah Scientific Technical Services and tips on discussing equipment problems.

- **Appendix A**

"Specifications" lists all system specifications, including Audio, Video, physical, power, and regulatory.

- **Appendix B**

"The Debug Port" contains information regarding the current Utah 400 firmware, along with setup and use of the system Debug Cable.

- **Appendix C**

"The Utah 400 Digital Audio Breakout Panel" applies to the installation and operation of the AES Digital Audio Break Out Panel, a component designed to simplify the installation of the Utah-400 Balanced Digital Audio Routing System.

Conventions

The following conventions are used throughout this guide:

- Connectors and terminators will be indicated by bold, upper case text in Arial Black font. For example:
 - Connect the **MX-Bus** to **J-1**
- **Operator Actions** will be indicated in Helvetica Bold where a board is inserted, removed and/or an action is required in the Troubleshooting or configuration sections of this manual. There will usually be a graphic to accompany the instruction(s). For example:
 - **Insert** the expansion Input board in slot 6.
 - **Switch** the suspected bad input **to a known good input** to verify output "X".
- The use of bullets indicates a random order of operation or to draw the readers attention to specific items.
 1. The use of numbers in specific operations or lists indicates a "**recommended order of operation**" to perform specific tasks. Bulleted items may be below numbered items to highlight tasks or indicate the operation(s) may be performed at random.

Abbreviations

The following abbreviations may be used in this guide: See Appendix A for an additional Glossary of Terms and further definitions.

TABLE 1. Common Abbreviations and Mnemonics

| Abbreviation | Description |
|---------------------|----------------------------------|
| ATR | Audio Tape Recorder |
| AES | Audio Engineering Society |
| CPU | Central Processing Unit |
| DTR | Digital Tape Recorder |
| EBU | European Broadcast Union |
| ENET | Ethernet |
| HDTV | High Definition Television |
| I/O | Input / Output |
| IP | Internet Protocol |
| JPEG | Joint Photographic Experts Group |
| M-JPEG | Motion – JPEG |
| MPEG | Motion Picture Experts Group |
| MX-Bus | Utah Router Control Comm. Bus |
| RMS | Router Management System |
| RU | Rack Unit |
| SDI | Serial Digital Interface |
| U-Net | Utah Control Panel Comm. Network |
| UTP | Unshielded Twisted Pair |
| VTR | Video Tape Recorder |

Terms

The following terms are used throughout the documentation in this guide:

- **"Operator"** and **"User"** refer to the person using or operating the Utah-400 Digital Router System.
- **"System"** refers to the entire interconnected Utah-400 System including control panels, routers, software, and chassis.
- **"Mainframe"** refers to the Utah-400 chassis plus redundancy.
- **"Input"** refers to an audio or video signal source that is connected to the Utah-400 main frame.
 - One video input represents one High Definition or Serial Digital Interface video output signal.
 - One audio input represents a single monophonic track from an analog audio source.
 - One digital audio input represents two tracks (left and right channel) from a digital audio source.
- **"Source"** refers to an audio or video device whose output signals are connected to the Utah-400 mainframe inputs. Examples of audio / video sources are ATR's, VTR's, DTR's, cameras, video / audio routers, audio mixers, graphics systems, and satellite feeds.
- **"Output"** refers to the Utah-400 audio or video signals from the Utah-400 "Outputs", which are connected to the 'destination device'. This term also includes the physical output connectors on the frame.
- **"Destination"** refers to the device, which is receiving the Utah-400 output signal. This could include VTRs, monitors, satellite feeds, or video / audio routers.
- **"Signal Level"** refers to the logical level of the audio / video routers in relation to the entire connected system(s). Typically, the Utah-400 occupies levels above 1, with master control occupying the lowest logical level.
- **"Hot Swappable"** refers to a printed circuit board, which can be removed or replaced with system power "on".
- **"Control Panel"** refers to the physical human interface used to control the various systems in use.
- **"Display"** is the 'LCD Display' on the panels in use.

- **"Monitor"** refers to the monitor attached to the monitor matrix port of a video or audio router system.
- **"High Definition"** " refers to signals conforming to the SMPTE -292 specification. The typical high definition data rate is 1.485 Gb/sec or 1.483 Gb/sec and a 16:9 Aspect Ratio Picture characterizes this technology.
- **"Serial Digital" Interface (SDI)"** refers to the serial digital video signal operating at either SMPTE -259 in ABCD or SMPTE -344.

Routing Switcher Basics

A routing switcher is a specialized form of broadcast equipment that allows the user to connect large numbers of source and destination devices together electronically – without patching or running cables across floors and without significant signal loss.

The routing switcher solves connectivity problems and increases signal qualities in a wide variety of applications. The technologies of routing switchers now include the standard analogue, digital video, digital audio, and increasingly the high definition formats.

The routing switcher provides the user with the following advantages:

- Many signal levels (determined by the system size) may be switched simultaneously.
 - A simple route connects (switches) one signal level from one source (for example a VTR) to one destination (a monitor).
 - A complex route would connect multiple signal levels from one source to multiple destinations, including tie lines. For example, a satellite feed to a group of VTRs and monitors.
- Audio and video signal levels can be switched in groups (all follow takes) or individually (breakaway takes). Any input can be switched to any output, limited only by the matrix size.
- The Routing Switcher may be controlled manually via control panels, or with computer controlled automation.

Switching Matrix

A switching matrix is the internal array of inputs, crosspoints and outputs that allow a routing switcher to perform the task of routing signals from sources to destinations. The figure below illustrates a simple 10 X 10 switching matrix – with 10 Inputs and 10 Outputs.

Note the following points regarding the illustration:

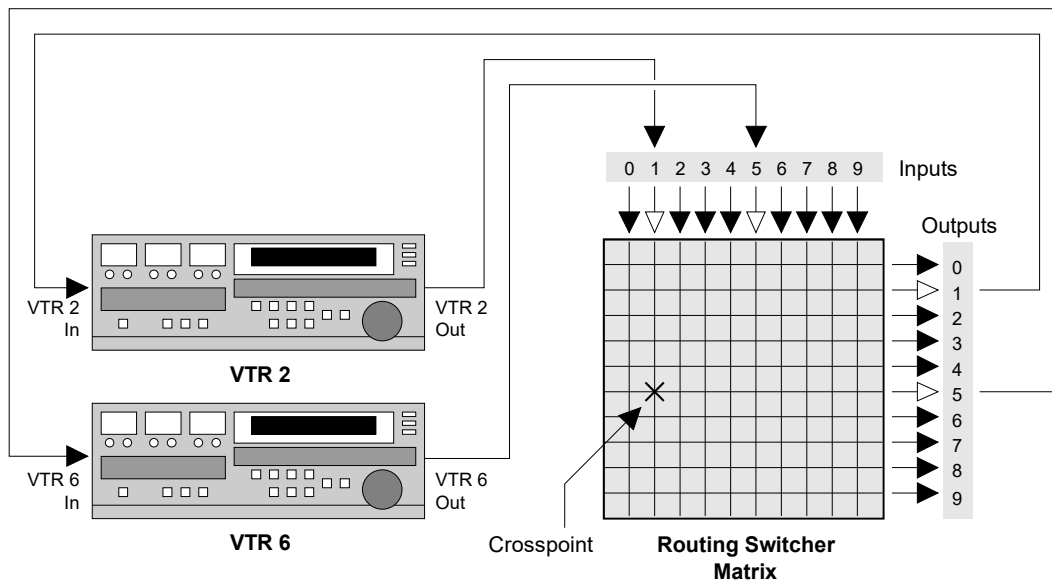

- Each VTR is fully connected to the matrix – all audio/video inputs and outputs.
- A cross-point (represented by an **X**) is the internal electronic connection of the input to the output – either audio or video.
- When the cross-point is turned "**ON**" the connection is made between the source and destination. The action of turning the cross-point on is known as making a "**Take**".
- When an entire audio/video array is connected in this manner, from all of the devices in your facility, you have full routing flexibility.
- Without re-cabling or re-patching, a device can play back one moment (as a source) and record the next moment (as a destination).

Signal Levels

A "signal level" represents one of many specific types of audio or video elements that a routing switcher is capable of handling. The typical signals capable of being switched are:

- Analog Video
- Analog Audio (stereo with left and right channels).
- Digital Video
- Digital Audio (dual channel – stereo pair)
- High Definition Video.

Some systems may be configured with one signal level, while others may be configured with multiple signal levels.

While the diagram in the previous section shows only one signal level, a multi-signal level system is capable of routing any combination up to 32 levels – each with its own matrix and cross-points.

The figure below illustrates **eight signal levels** in a 10 X 10 matrix system.

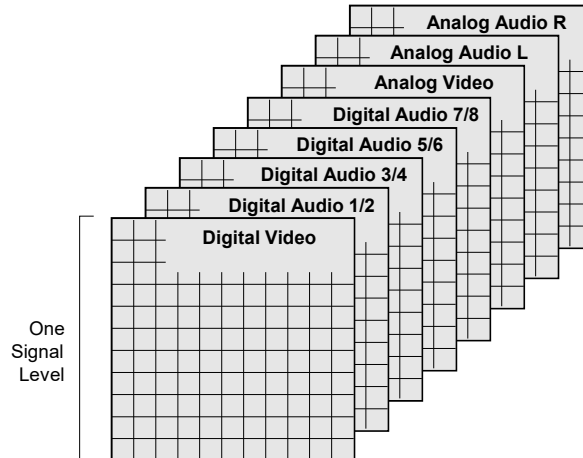

Signal routers are typically much larger than a 10 X 10 matrix, depending on user needs. Each signal level may also have different sizes of matrices and do not all need to be the same size.

The Utah-400 Routing Matrix

The Utah-400's unique matrix technology allows for a greater flexibility of input and output combinations available to the user. Each input or output board contains eight signal paths so the user can expand in groups of eight up to the maximum capacity of the router. These I/O cards can be HD, SD, or Analog in a video router, and AES or analog in an analog router.

The crosspoint board and its flexible design characterize the Utah-400 system. This board is available in the 144 x 144 matrix. All crosspoint switching is input coincident, consistent with previous Utah Scientific technologies.

Chassis demographics require all input board to be installed above the midplane (crosspoint) in the chassis; all output boards are installed below the midplane in the chassis.

Features of this technology include signal presence indicators on both the input and output boards. The status of the router input and output states can be continuously monitored via the debug port (see Appendix B).

Refer to the Utah-400 Matrix Block Diagram for the following signal routing description.

The input signal is received and equalized on the input board. A valid input will illuminate the Signal Presence Detector LED and also status at the debug port.

From this point the signal is routed to the crosspoint, where the operator has made a "Take", selecting the routing path of this input to its output.

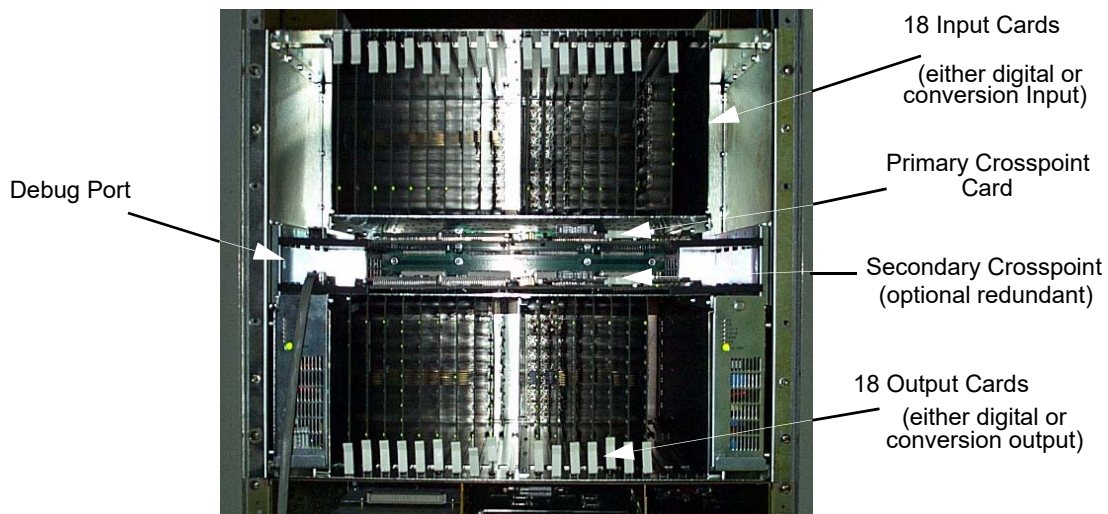

FIGURE 1-1. Utah-400 (front view)

The output from the crosspoint is directed to its proper path on the output bus and the appropriate output board slot. When the output board detects a valid output signal, it will illuminate the appropriate Signal Presence LED. From this point the output signal is sent to its output driver and its BNC.

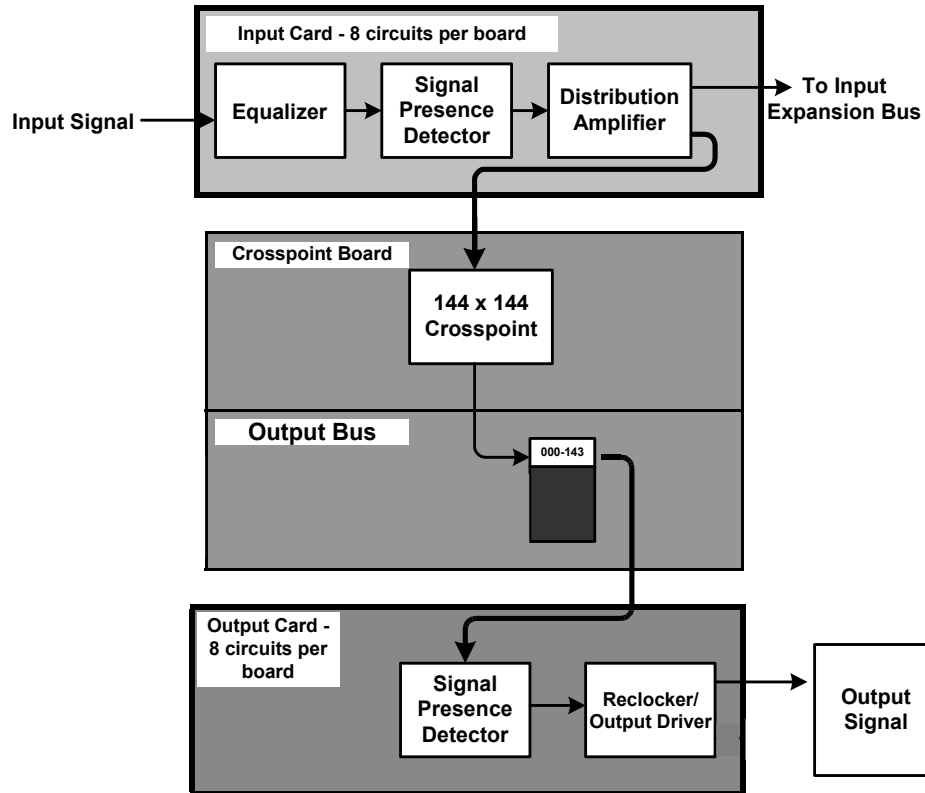

FIGURE 1-2. The Utah-400 Matrix Block Diagram

Introducing the Utah-400 Digital Routing Switcher

Utah Scientifics' **Utah-400 Digital Routing System** incorporates the latest technology and is designed to meet the most demanding user needs in the router switching market.

The Utah-400 offers the following features:

- Digital Audio and Video switching matrices from 144 X 144 up to 1152 X 1152.
 - All routers utilize the same chassis as building blocks for all configurations.
 - Very compact – 144 x 144 = 8 RU; 288 x 288 = 16 RU; 576 x 576 = 48 RU.
 - Frames are 8 Rack Units (RU) High. (14 inches / 35.6 cm)
 - Fully redundant Power Supplies and AC sources. (Separate plugs for each chassis supply.)
 - Low power consumption – 144 x 144 HD = < 300 Watts.
 - Four cooling fans with rear exhaust. Chassis will cool itself with two fans running.
 - Fans replaceable without powering down router.
 - Low density Input/Output Blocks: 8 channel Input / Output boards.
 - No external connections required to expand inputs.
 - Flexible Input/Output combinations for each chassis.
 - *No Input presence indicators (LEDs) on the SDI Input boards*
 - Router expansions are field upgradeable.
 - All circuit boards insert and extract from the front of the router, less downtime when troubleshooting problems.
- Compatible with existing control systems.
 - Uses the existing Utah Scientific MX-Bus Router Interface.
 - UNET
 - Internet
 - RS-232 / RS-422
 - Personal Computer
- Error Indicators include voltage, fan and temperature.
- Redundancy used to avoid a single point failure where possible.
- Non-Intrusive diagnostics and status reports when interfacing with a personal computer.

- Utah –400 Digital Video Systems:
 - Will accommodate SD and HD video in the same chassis.
 - HD boards designed to handle SD
 - Data Rates:
 - SD Re-clocking Rates include 143, 177, 270, 360, and 540 Mb/sec.
 - HD Re-clocking Rates include the SD rates above plus 1.485 Gb/sec.
- Utah-400 Digital Audio Systems:
 - Will accommodate synchronous and asynchronous digital audio inputs.
 - Balanced and Unbalanced Inputs and Outputs can be installed in the same chassis.
 - Direct or transformer coupling for input and output boards available.
 - Conforms to AES3-1992 Specification; 48 kHz, 24 bit.
- The Utah-400 Crosspoint Board.
 - 144 squared matrix.
 - One Monitor Matrix output per crosspoint.
 - Available with redundant control modules.
 - A Redundant Crosspoint chassis is available that increases the height to 9 rack units.

System Configurations

The chassis configurations for the Utah-400 Digital Router contain two variations; redundant and non-redundant.

- Variations are subject to the customer's requirements.

Sample Configurations

The 144 configuration is shown below.

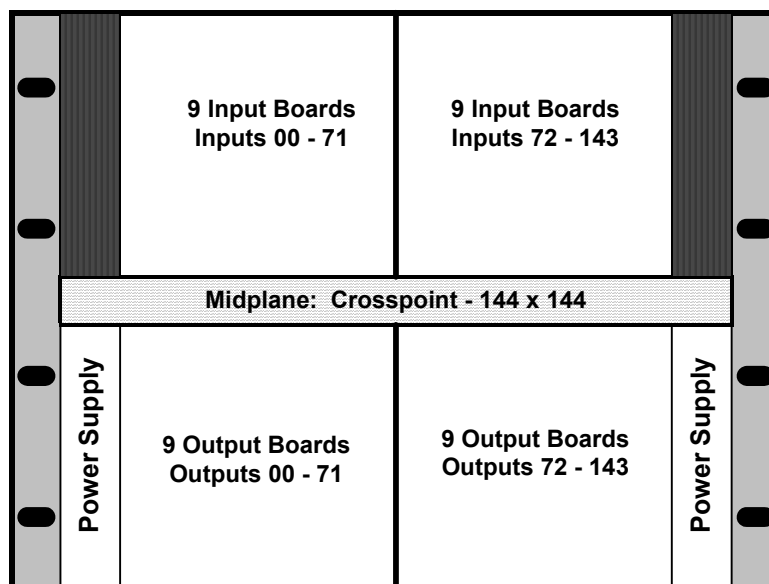

FIGURE 1-3. The Utah-400 144 x 144 Configuration

- The 144 x 144 Router Includes:
 - 1) Crosspoint Board (144 x 144)
 - 18) Input Boards (000 – 143)
 - 18) Output Boards (000 – 143)
 - 2) Power Supplies

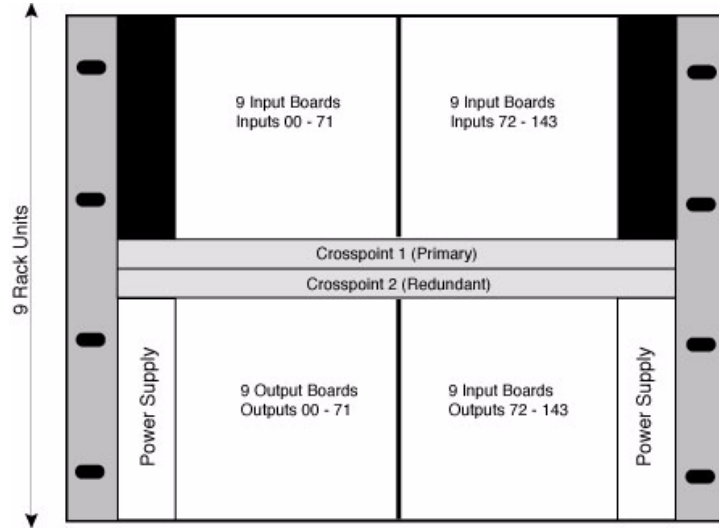

FIGURE 1-4. 144x144 with Redundant Crosspoints

In This Chapter

This chapter provides instructions for installing your Utah-400 router in your facility. The following topics are covered:

Caution: *To avoid damage to the system, do not connect AC power until the hardware is fully installed.*

| | |
|--|------|
| Unpacking and Inspection | 2-2 |
| Installing Physical Equipment | 2-3 |
| Mounting Equipment in Rack Frames | 2-3 |
| Installing the MX-Bus Cables | 2-6 |
| Installing the Analog Audio Input and Output Cables .. | 2-16 |
| Connecting and Disconnecting Power | 2-21 |
| Hardware Checkout | 2-24 |

Unpacking and Inspection

When you receive your Utah-400 system, inspect each shipping carton for signs of damage. Contact your dealer and shipper immediately if you suspect any damage has occurred during shipping. Check the contents of each carton against your Utah Scientific order and verify them against the shipping manifest. If any items are missing, contact your dealer or Utah Scientific immediately.

Save the shipping box and material for future use, in case the unit may have to be shipped back to Utah Scientific.

Caution: *The Utah-400 router weighs approximately eighty pounds; with shipping materials and accessories the box weight may equal more than ninety pounds.*

Each router is wrapped in anti-static plastic prior to boxing up. Figure 2-1 shows the typical packaging of a single Utah-400 router.

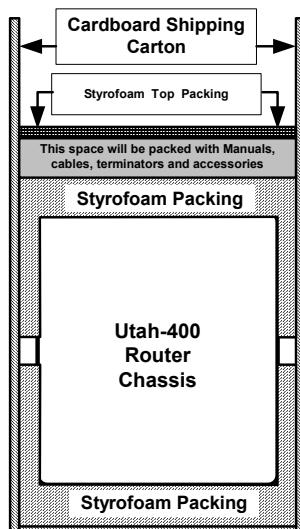

FIGURE 2-1. Utah-400 Packaging

Recommended unpacking method:

1. With carton setting upright, open the top.
2. Remove the Styrofoam packing material in the top of the box.
3. Remove the accessories.

4. Remove the Styrofoam packing from the top of the Utah-400.
5. Grasp the sides of the Utah-400 and gently pull it up and out of the bottom Styrofoam packing material and box.
6. Place the Utah-400 on a stable bench or cart.
7. With the Utah-400 sitting on a bench or cart, remove the anti-static wrap covering the router and save for future use.
8. Move the router to the installation site.

Installing Physical Equipment

Installation of your Utah-400 Video and/or Audio router may require some or all of the following steps:

1. Mounting equipment in rack frames.
2. Installing MX-Bus cables.
3. Connecting the AES Reference Signal.
4. Determining and Setting the Router Signal Level(s).
5. Installing Audio/Video signal cables.
6. Connecting power.
7. Connecting the SMPTE alarm port.
8. Hardware checkout.

Mounting Equipment in Rack Frames

Installing the Utah-400 Digital Routing Switcher

Use the following steps to install the Utah-400 Systems into the rack frames:

1. Determine the vertical layout of your frames before you begin the installation. Please note:
 - You may wish to place blank panels between the systems to increase ventilation and make cabling easier.
 - You may wish to install the systems in a way to reflect the priority of audio and video signal levels.

- **For example:** If digital video is signal level 1 and digital audio is signal level 2, the digital video may occupy a lower position in the rack frame.

Note: See Figure 2-2 for an example rack frame layout.

2. Once your layout is determined, remove the front cover from the Utah-400 and set it aside.

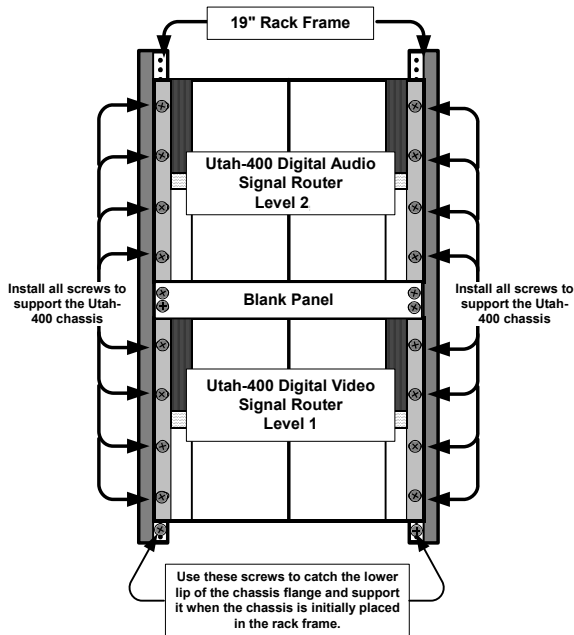

FIGURE 2-2. Utah-400 Chassis Mounted in 19" Rack Frame

3. Remove the shipping braces and set them aside.
4. Install the Utah-400 chassis' in the 19" rack frame.

Note: *The 144 x 144 chassis (with power supplies and PCB's) weighs close to 80 pounds; Utah Scientific recommends a minimum of two persons, preferably three, to install the chassis in the rack frame. Install all mounting screws in the front of the chassis; the entire weight of the router and cables are supported by the chassis side-frames.*

- a. Determine the height to mount the Utah-400 in the rack frame.

- b. Install two rack screws 3/4 of the way into the empty rack frame below the height determined in step a, above (leave a 1/8" gap). These screws will be used to support the weight of the chassis when it is moved into the rack frame. See Figure 2-3, Section A.
- c. With two persons, pick the chassis up from the shipping carton at the left and right side frames.
- d. Move the chassis to the 19" rack frame and carefully slide it into the rack frame, hooking the flange of the chassis above the rack screws installed in step b., above. See Figure 2-3, Section B.

Note: *An alternative method is to support the Utah-400 Chassis with a shelf or similar support and align the mounting holes accordingly.*

- e. With the chassis resting on the lower rack screws, carefully lift the left side frame, align the lowest chassis frame mounting hole with a rack frame threaded hole and start rack screw. Repeat for the right hand side frame.
 - f. Once the lower chassis rack screws are in place, snug both sides up, but do not tighten.
 - g. Align remaining six mounting holes, install remaining six rack screws through mounting holes and then snug them down.
 - h. Finally, tighten all eight rack screws installed in the chassis mounting holes.
5. Replace all front covers when the installation is complete.

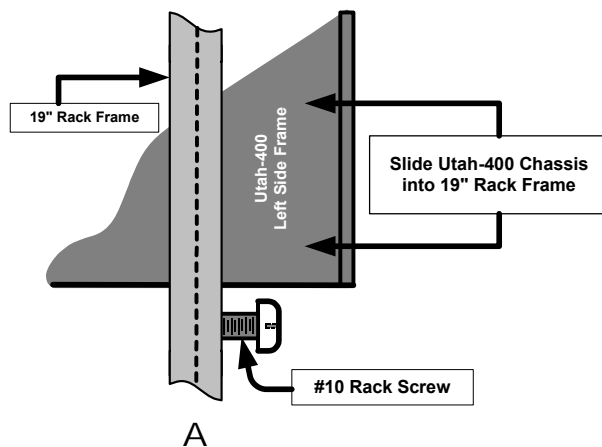

FIGURE 2-3. Sliding the Utah-400 Chassis into Rack Frame

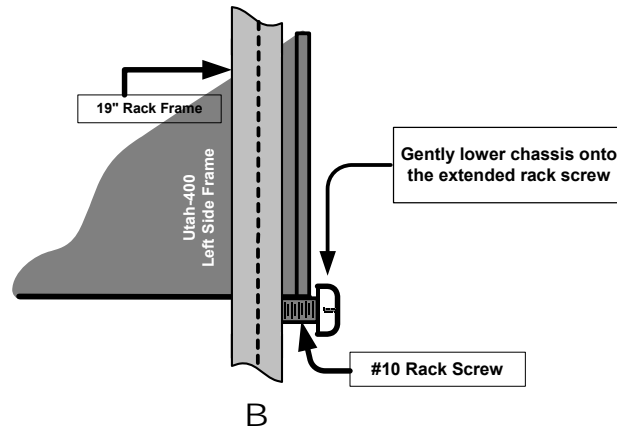

FIGURE 2-4. Lowering the Utah-400 Chassis on the Rack Screw

Installing the MX-Bus Cables

The Utah-400 routing system utilizes the MX-Bus control system. It must be connected to the SC-3 or SC-4 control system to switch its inputs and outputs. In addition, the proper levels and offsets must be set on the Utah-400 routing system(s) so they will operate on the proper signal levels.

The MX-Bus is a daisy chain configuration, must not exceed 300 feet (91.4 meters) in length; and must be terminated at both ends of the daisy chain.

Your Utah-400 router is shipped standard with:

- One MX-Bus Cable – 10 ft. (USI Part Number: 80229-10). Other lengths are available and may be ordered through Utah Scientific sales at 1-800-453-8782.

Interconnecting the SC-3 and Utah-400 Frames

The MX-Bus interconnection to the Utah-400 typically starts at the SC-3 control system and is terminated at the last physical Utah-400 chassis. The actual physical arrangement depends on the site placement of the various physical components.

Installing the MX-Bus Cables

The following illustration shows a typical MX-Bus installation.

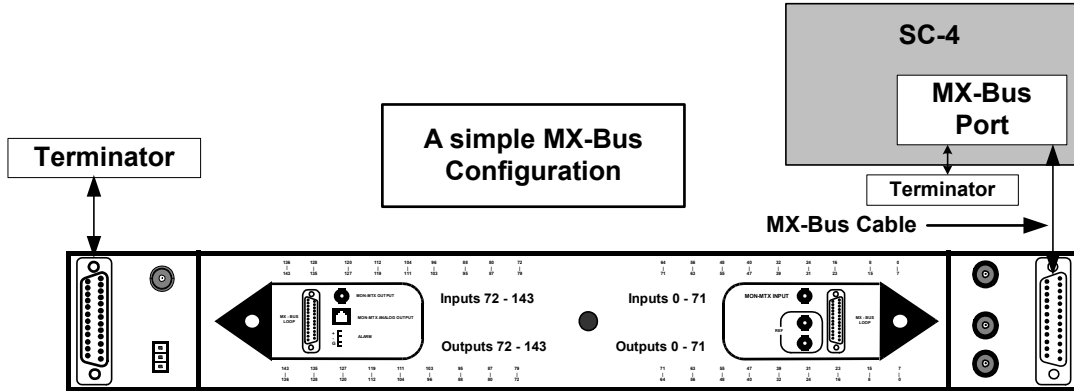

FIGURE 2-5. The MX-Bus Installation to an SC-4 Controller

Note: The Video Backplane is shown here.

The following illustration is a block diagram showing the Utah-400 in an MX-Bus daisy chain with other Utah Scientific equipment.

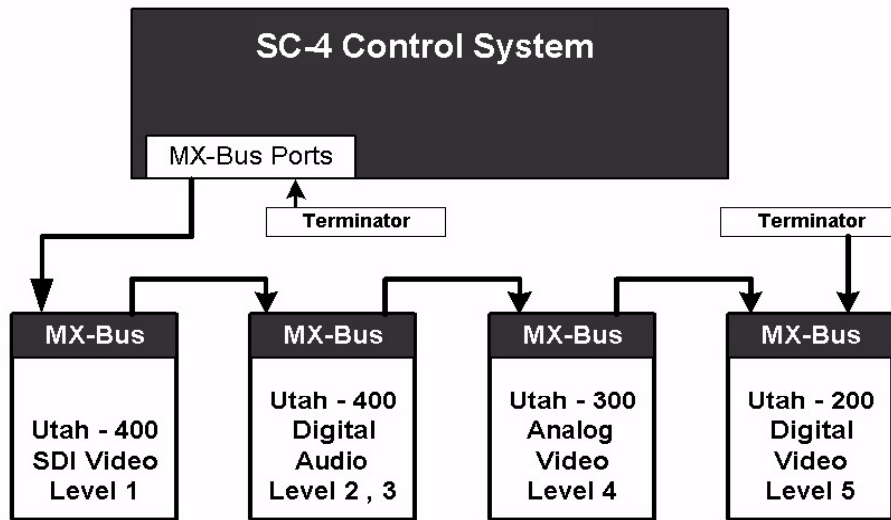

FIGURE 2-6. Block Diagram of the MX-Bus Daisy Chain.

Connecting the AES Reference Signal

The AES Reference input BNC connectors are located on the right hand side of the Utah-400 midplane (facing the backplane).

These BNC signal connections are looped-thru and must be terminated with a 75 Ohm, 1% BNC Terminator, if not daisy chained to another reference input.

The Reference signal is required so the Utah-400 Digital Audio Router can switch on the **frame boundary**. Using the Sync signal avoids the possibility of clicks in the digital audio while switching.

The following signal is acceptable to used as the Utah-400 AES Reference:

- AES Sync must be AES-3.

- The following illustration shows the typical AES Reference cabling.

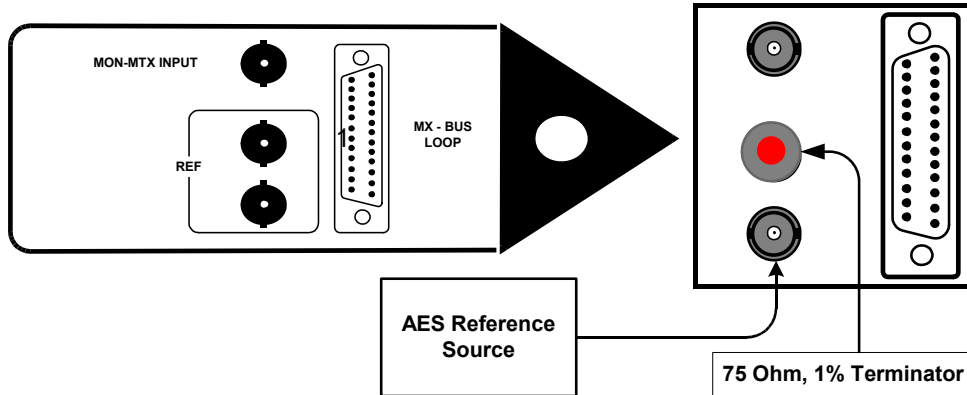

FIGURE 2-7. AES Reference Cabling

Determining and Setting Router Signal Levels

Signal levels are preset at the factory and tested during manufacturing, determined by customer input and requirements. The installation of your new Utah-400 Router should not require any signal level changes to operate after the new installation.

By definition, a signal level represents distinct elements of the broadcast system. These individual elements include, but are not limited to, High Definition Video, SDI Video, Digital Audio, Analog Video, Analog Audio and Data Routers. For additional information relating to signal levels, refer to the Introduction, Page 1-7.

Should you ever need to change the signal level of your router it is useful to determine:

- What new signal level is required.
- If other signal levels will have to be modified to accommodate the new signal level.
- Additional encoding requirements necessitated by the change.

To change the Utah-400 Router Signal Level:

Note: *The Utah-400 crosspoint board must be powered down or reset for it to recognize any configuration changes made to the dipswitches. If the router has on-air signals present do not attempt a reconfiguration until it can be completed during the off-air time slots.*

1. If the Utah-400 is not powered down, disconnect it from the power source.

2. Remove the front cover from the Utah-400.
3. Pull the Crosspoint slightly out of the router using the board ejectors located on the left and right hand sides of the board. (The crosspoint board does not have to be removed from the chassis to change configuration.)
4. On the Crosspoint Board, at the midplane, locate the Configuration Dipswitch. See the following illustration.

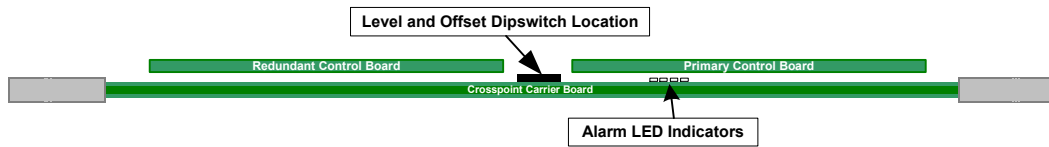

Crosspoint Board - Looking at the Front

FIGURE 2-8. Crosspoint Carrier Board Dipswitch Location

5. There are two eight-position dipswitches on the Crosspoint Carrier Board. The Level Dipswitch is located toward the front of the board; the Offset Dipswitch is located just behind the Level dipswitch. See the following figure.
6. Reference Table 2-1 to set the Level dipswitches and Table 2-2 to determine which switches must be changed for the Level desired.
7. Reference Table 2-3 to set the Offset dipswitches per your requirements.

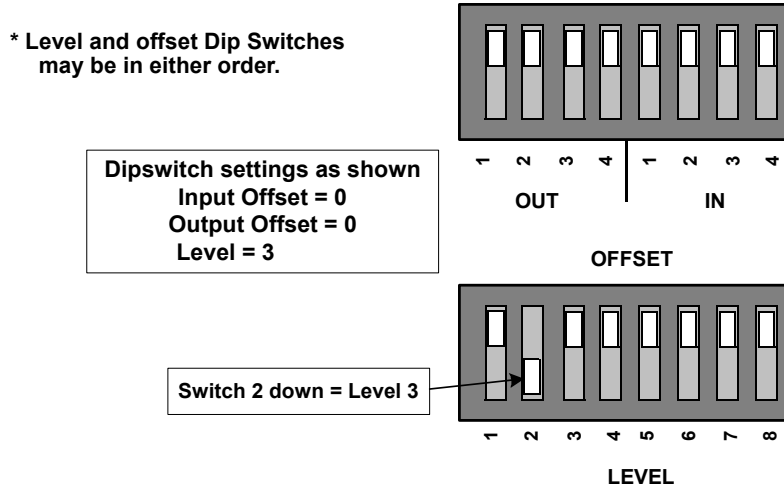

FIGURE 2-9. Utah-400 Configuration Dipswitches as they appear on the Crosspoint Carrier Board

TABLE 2-1. Utah-400 Level Dipswitch Settings

| Switch | SC-2 Function | SC-4 Function |
|--------|-----------------------------------|--------------------------------|
| 1 | On = Don't Care Off = Level 1 | On = Level 1 Off = Level 2 |
| 2 | On = Don't Care Off = Level 2 | On = Level 1 Off = Level 3 |
| 3 | On = Don't Care Off = Level 4 | On = Level 1 Off = Level 5 |
| 4 | On = Don't Care Off = Level 8 | On = Level 1 Off = Level 9 |
| 5 | On = Don't Care Off = Level 16 | On = Level 1 Off = Level 17 |
| 6 | Not Assigned | Not Assigned |
| 7 | Not Assigned | Not Assigned |
| 8 | Not Assigned | Not Assigned |

TABLE 2-2. Level Assignment Per Dipswitch Selection.

Note: Not all Signal Levels are shown.

| SC-4 Depswitch Assignment | | | | | | | |
|---------------------------|-----|-----|-----|----|----|----|----|
| Switch Number | | | | | | | |
| 1 | 2 | 3 | 4 | 5 | 6 | 7 | 8 |
| On | On | On | On | On | On | On | On |
| Off | On | On | On | On | On | On | On |
| On | Off | On | On | On | On | On | On |
| Off | Off | On | On | On | On | On | On |
| On | On | Off | On | On | On | On | On |
| Off | On | Off | On | On | On | On | On |
| On | Off | Off | On | On | On | On | On |
| Off | Off | Off | On | On | On | On | On |
| Of | Off | Off | Off | On | On | On | On |

TABLE 2-3. Utah-400 Offset Dipswitch Settings

| Input/Output Offset Switch | Function | Description |
|----------------------------|--------------------------|--|
| 1 | Input/Output Offset 144 | Offsets Base input/Output by 144 from 0 |
| 2 | Input/Output Offset 288 | Offsets Base input/Output by 288 from 0 |
| 3 | Input/Output Offset 576 | Offsets Base input/Output by 576 from 0 |
| 4 | Input/Output Offset 1152 | Offsets Base input/Output by 1152 from 0 |

Installing the Video/Unbalanced Digital Audio Input & Output Signals

This section provides guidelines for installing the Utah-400 Video Inputs and Outputs on the backplane connectors. Serial Digital Video and Audio cable specifications are listed below.

| Input Signal | Recommended Cable Type | Maximum Cable Length | Termination Method |
|--|------------------------|----------------------|--------------------|
| Digital Video and Unbal. Digital Audio | Belden 8281 | 300 M. / 1000' | Internal - 75 Ohm |
| High Definition Digital Video | Belden 8281 | 100 M. / 300' | Internal - 75 Ohm |
| | Belden 1694A | 150 M. / 500' | Internal - 75 Ohm |
| | Belden 7731 | 200 M. / 600' | Internal - 75 Ohm |

The following recommendations are made regarding cable connections:

- Ensure the router frames are installed securely in the equipment racks.
- Due to the compactness of the Utah-400 rear panel BNC's, it may be useful to have a connector chart next to the backplane.
- The use of a BNC insertion / extraction tool is recommended.
- Label the Input and Output cables coming into the rear panel – for example:
- VTR1 – Video Out or Out 0 – VTR1.
- All Utah-400 Digital Video/Unbalanced Audio BNC's use 75-Ohm single ended connectors.
- Avoid stress on the lower backplane BNC connections by providing proper strain relief on all cables.
- The Utah-400 Input matrix starts with Input 0 at the top right of the backplane.
- The Utah-400 Output matrix starts with Output 0 at the bottom right.
- Due to the 75 Ohm internal termination, do not use BNC "T" connectors to loop an input signal. This will result in serious signal degradation.

Figure 2-10 shows the entire Utah-400 144 x 144 Matrix rear panels. (Video or unbalanced digital audio.)

Figure 2-11 shows the Input rear panel connector matrix, use this matrix to connect the input cables to the chassis.

Figure 2-12 shows the Output rear panel connector matrix, use this matrix to connect the output cables to the chassis.

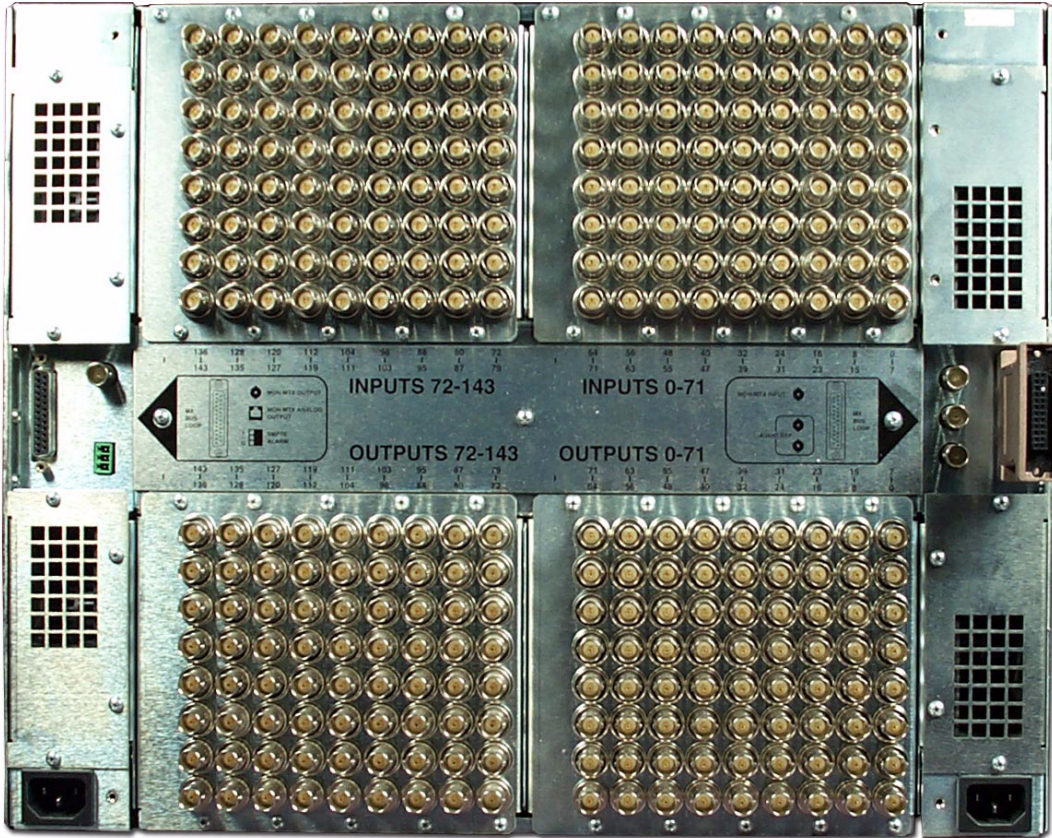

FIGURE 2-10. Utah-400 144² Video Unbalanced Audio Rear Panels

| | | | | | | | | | | | | | | | | | |
|-----|-----|-----|-----|-----|-----|-----|-----|-----|-----|-----|-----|-----|-----|-----|-----|-----|-----|
| 136 | 128 | 120 | 112 | 104 | 096 | 088 | 080 | 072 | 064 | 056 | 048 | 040 | 032 | 024 | 016 | 008 | 000 |
| 137 | 129 | 121 | 113 | 105 | 097 | 089 | 081 | 073 | 065 | 057 | 049 | 041 | 033 | 025 | 017 | 009 | 001 |
| 138 | 130 | 122 | 114 | 106 | 098 | 090 | 082 | 074 | 066 | 058 | 050 | 042 | 034 | 026 | 018 | 010 | 002 |
| 139 | 131 | 123 | 115 | 107 | 099 | 091 | 083 | 075 | 067 | 059 | 051 | 042 | 035 | 027 | 019 | 011 | 003 |
| 140 | 132 | 124 | 116 | 108 | 100 | 092 | 084 | 076 | 068 | 060 | 052 | 043 | 036 | 028 | 020 | 012 | 004 |
| 141 | 133 | 125 | 117 | 109 | 101 | 093 | 085 | 077 | 069 | 061 | 053 | 044 | 037 | 029 | 021 | 013 | 005 |
| 142 | 134 | 126 | 118 | 110 | 102 | 094 | 086 | 078 | 070 | 062 | 054 | 045 | 038 | 030 | 022 | 014 | 006 |
| 143 | 135 | 127 | 119 | 111 | 103 | 095 | 087 | 079 | 071 | 063 | 055 | 047 | 039 | 031 | 023 | 015 | 007 |

FIGURE 2-11. Unbalanced Digital Audio/Digital Video Input Connector Matrix

| | | | | | | | | | | | | | | | | | |
|-----|-----|-----|-----|-----|-----|-----|-----|-----|-----|-----|-----|-----|-----|-----|-----|-----|-----|
| 143 | 135 | 127 | 119 | 111 | 103 | 095 | 087 | 079 | 071 | 063 | 055 | 047 | 039 | 031 | 023 | 015 | 007 |
| 142 | 134 | 126 | 118 | 110 | 102 | 094 | 086 | 078 | 070 | 062 | 054 | 045 | 038 | 030 | 022 | 014 | 006 |
| 141 | 133 | 125 | 117 | 109 | 101 | 093 | 085 | 077 | 069 | 061 | 053 | 044 | 037 | 029 | 021 | 013 | 005 |
| 140 | 132 | 124 | 116 | 108 | 100 | 092 | 084 | 076 | 068 | 060 | 052 | 043 | 036 | 028 | 020 | 012 | 004 |
| 139 | 131 | 123 | 115 | 107 | 099 | 091 | 083 | 075 | 067 | 059 | 051 | 042 | 035 | 027 | 019 | 011 | 003 |
| 138 | 130 | 122 | 114 | 106 | 098 | 090 | 082 | 074 | 066 | 058 | 050 | 042 | 034 | 026 | 018 | 010 | 002 |
| 137 | 129 | 121 | 113 | 105 | 097 | 089 | 081 | 073 | 065 | 057 | 049 | 041 | 033 | 025 | 017 | 009 | 001 |
| 136 | 128 | 120 | 112 | 104 | 096 | 088 | 080 | 072 | 064 | 056 | 048 | 040 | 032 | 024 | 016 | 008 | 000 |

FIGURE 2-12. Unbalanced Digital Audio/Digital Video Output Connector Matrix

Installing the Analog Audio Input and Output Cables

The following recommendations are suggested for installing the Analog Audio Inputs and Outputs.

- Ensure the Utah-400 Chassis are installed securely to the equipment rack.
- Label all cables going to the Inputs and Outputs, for example:
 - **Inputs 0-7: VTR1 – 0, VTR2 – 1, SAT –4 ...**
 - **Cable-1; Inputs 0-7, see Chart 1....**
- Pre-wired cables are available from Utah Scientific.
- D-connector to terminal block. Breakout panels are available from USI. (BDA-400)
- Inputs and Outputs can be connected directly to the backplane using 26 pin high-density "D" connectors and back shells. (Supplied with the system) Contact Utah Scientific sales for more information.
- Additional strain relief should be provided for each "D" connector, in addition to the connector screws.

Refer to Appendix A – "Hardware Specifics" for wiring charts and a list of audio connector suppliers.

Figure 2-13 illustrates an example of a Utah-400 Analog Audio Backplane. Use this figure for Input/Output connector reference.

Table 2-4 shows the connector pin-out for the 26-pin high-density connectors.

Figure 2-14 shows a blown up view of the Male 26-pin high-density connector.

Figure 2-15 shows a blown up view of the Female 26-pin high-density connector.

Installing the Analog Audio Input and Output Cables

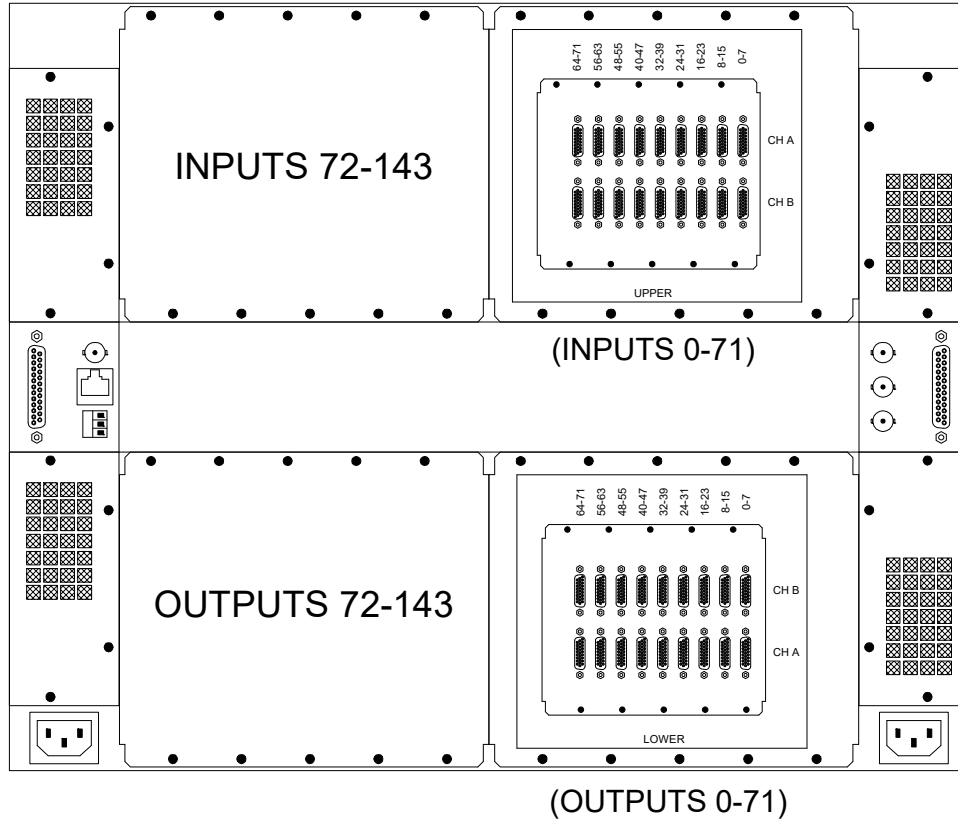

FIGURE 2-13. Utah-400 Analog Audio Backplane

The standard configuration for the Utah-400 Analog Audio Input and Output using DB-26 connectors (illustrated above).

The high-density DB-26 connector used on the backplane has the same wiring format for the input and outputs. Table 2-4 is a generic table and applies equally to the input and output wiring. Although any wiring scheme may be used, Utah Scientific makes the following recommendations:

- Use a high quality shielded cable for the Digital Audio. See the chart below.

| Recommended Cable | Maximum Cable Length | Physical Characteristics | Shielding |
|--------------------------|-----------------------------|---------------------------------|------------------------------------|
| Belden 9992 (or better) | 100 M. / 300' | 9 pair / 24 AWG / Stranded | Individual Shields and Drain wires |
| Belden 6387 (or better) | 100 M. / 300' | 9 pair / 24 AWG / Stranded | Individual Shields and Drain wires |
| Belden 1800A (or better) | 100 M. / 300' | 1 pair / 24 AWG / Stranded | Shield with Drain Wire |

Note: The cable shield should be grounded on the chassis end only; this prevents ground loops from occurring.

- Use shrink tubing around the end of the wires and cups on the 26-pin high-density male connector when assembling. This process helps prevent any shorting between adjacent wires.
- Tie all grounds together inside the connector shell. Use an EMI Gasket for this application.

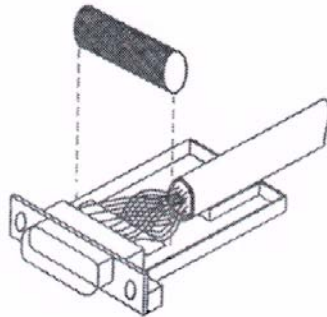

- Provide proper strain relief for the cable ends; use tie-wraps to anchor the cables as they are installed.
- Avoid running Digital Audio cables across or adjacent to AC power sources where possible.
- Do not bundle wires close to chassis backplane, this increases connector stresses.

TABLE 2-4. Utah-400 Balanced Digital Audio/Analog Audio (Pinout Connections)

| DB-26S (Female) | | DB-26S (Male) | |
|-----------------|------------|-------------------------|------------------|
| | | | |
| Pair | Pin Number | Signal | Drain Wire (GND) |
| 1 | 1 | Input/Output 0 + | 19 |
| | 11 | Input/Output 0 - | |
| 2 | 2 | Input/Output 1 + | 20 |
| | 12 | Input/Output 1 - | |
| 3 | 3 | Input/Output 2 + | 21 |
| | 13 | Input/Output 2 - | |
| 4 | 4 | Input/Output 3 + | 22 |
| | 14 | Input/Output 3 - | |
| 5 | 5 | Input/Output 4 + | 23 |
| | 15 | Input/Output 4 - | |
| 6 | 6 | Input/Output 5 + | 24 |
| | 16 | Input/Output 5 - | |
| 7 | 7 | Input/Output 6 + | 25 |
| | 17 | Input/Output 6 - | |
| 8 | 8 | Input/Output 7 + | 26 |
| | 18 | Input/Output 7 - | |
| N/A | 9 - 10 | Isolated Chassis Ground | N/A |

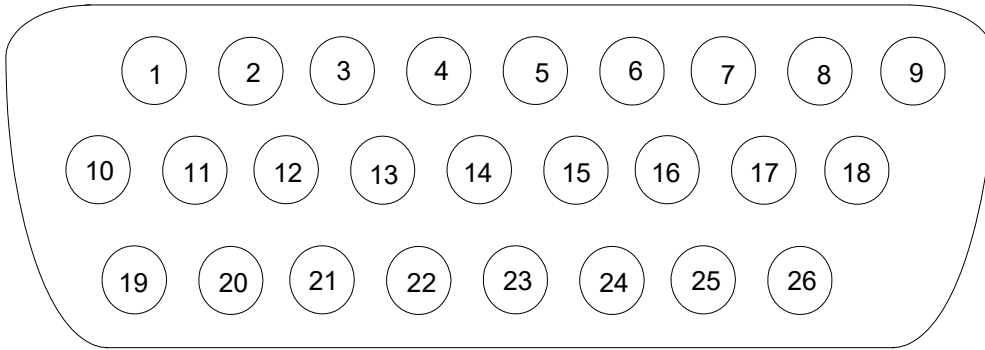

FIGURE 2-14. DB-26 High-Density Male Connector

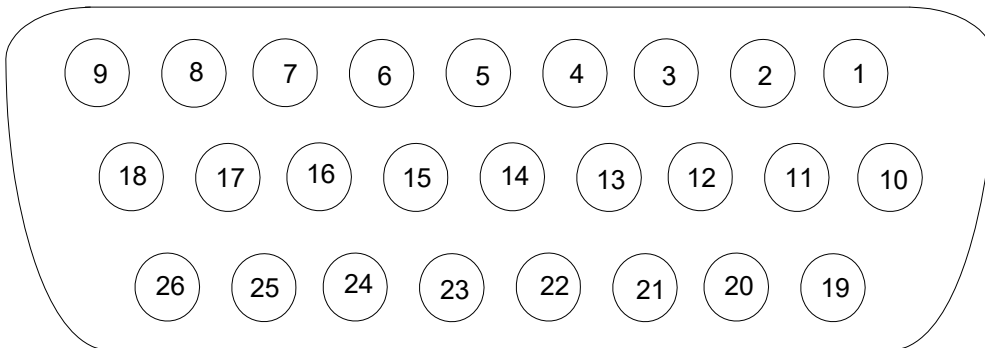

FIGURE 2-15. DB-26 High-Density Female Connector

Connecting and Disconnecting Power

AC Connectivity

The Utah-400 Audio and Video Routing Systems are designed for continuous power; there is no AC Power Switch on the router.

Important: The AC power cord is the only method which chassis power can be connected or disconnected. In case of an emergency, the user should have quick access to the AC plug.

Power redundancy is built into the Utah-400 Audio and Video Routing Systems. The power cords plug into the lower right and left hand sides of the chassis. Either AC source can power the routing system independently, provided redundant power supplies are ordered with the system.

This provides the flexibility to connect one AC Source to the standard utility source; with the second AC Source being connected to an uninterruptible system, such as a backup generator system.

Reference Figure 2-17, AC Power Connections, for the following explanation.

- On the back of the chassis locate the left and right AC NEMA connector.
- Plug the NEMA end of the power cord into the chassis NEMA socket.
- Plug the 3 pronged AC Plug into the desired AC source(s).

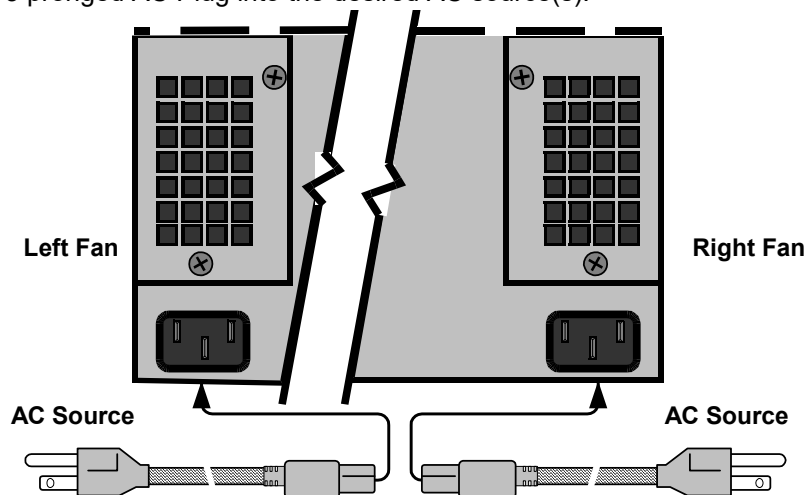
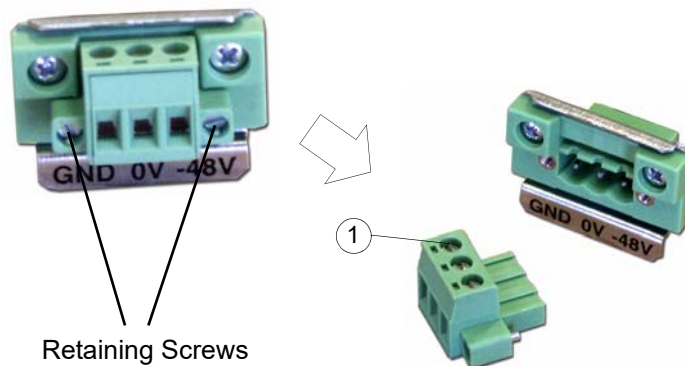

FIGURE 2-16. Utah-400 Power Connections

DC Connectivity

The DC input at the rear of the chassis is noticeably different than its AC counterpart. The connection consists of three separate terminals:

- Ground - Frame or chassis grounding point
- 0V - Most positive leg of -48V DC connection.
- -48V - Most negative leg of -48V DC connection.



Note that this configuration is a DC-I or DC isolated connection.

The terminal strip is a small bracket containing three screws (see 1). Loosen the screws to remove the terminal from the back. This will expose the strip of wire (aprox. 1/4 of an inch).

Proper wire insertion into the removable terminal block

- Turn the screws counter clockwise to allow wire insertion (3 screws on block top).
- Strip 1/4" of the insulation from the new wires.
- Insert wire, then turn screw clockwise to tighten

Use 12 AWG wire (maximum)

The maximum current required for the branch circuit feeding the UT-400 144 and UT-400 288 is 10 Amps.

Crosspoint Board LEDs

If no LED's on the Crosspoint board are on:

- Disconnect AC/DC Power from the router.
- Loosen the retaining screw and pull out one of the power supplies.
- Check the power supply Fuse (reference Fig 2-16 for the general location.)
- Repeat with redundant power supply if necessary.
- Reconnect AC/DC Power and observe if the Utah-400 power is normal.
- If the green Power Supply Good LED is not illuminated on the crosspoint, remove the crosspoint board and check fuse.
- Replace Fuse if necessary.

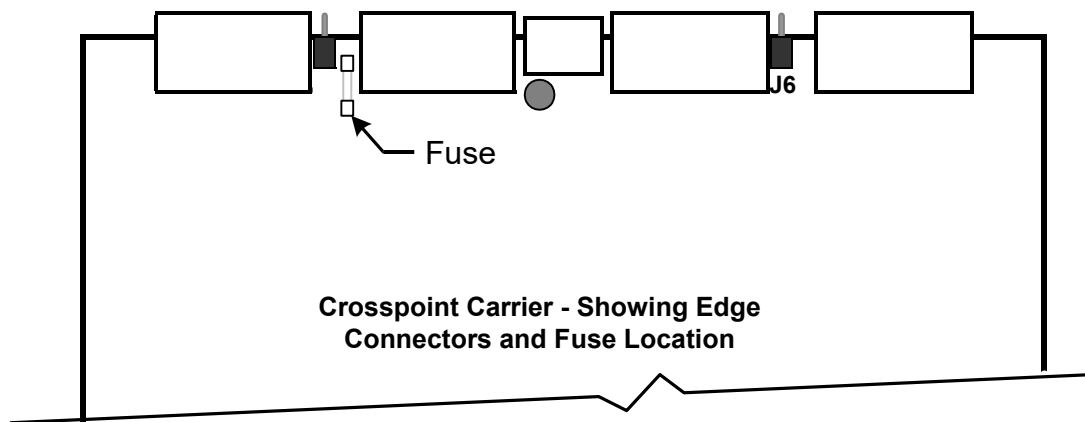
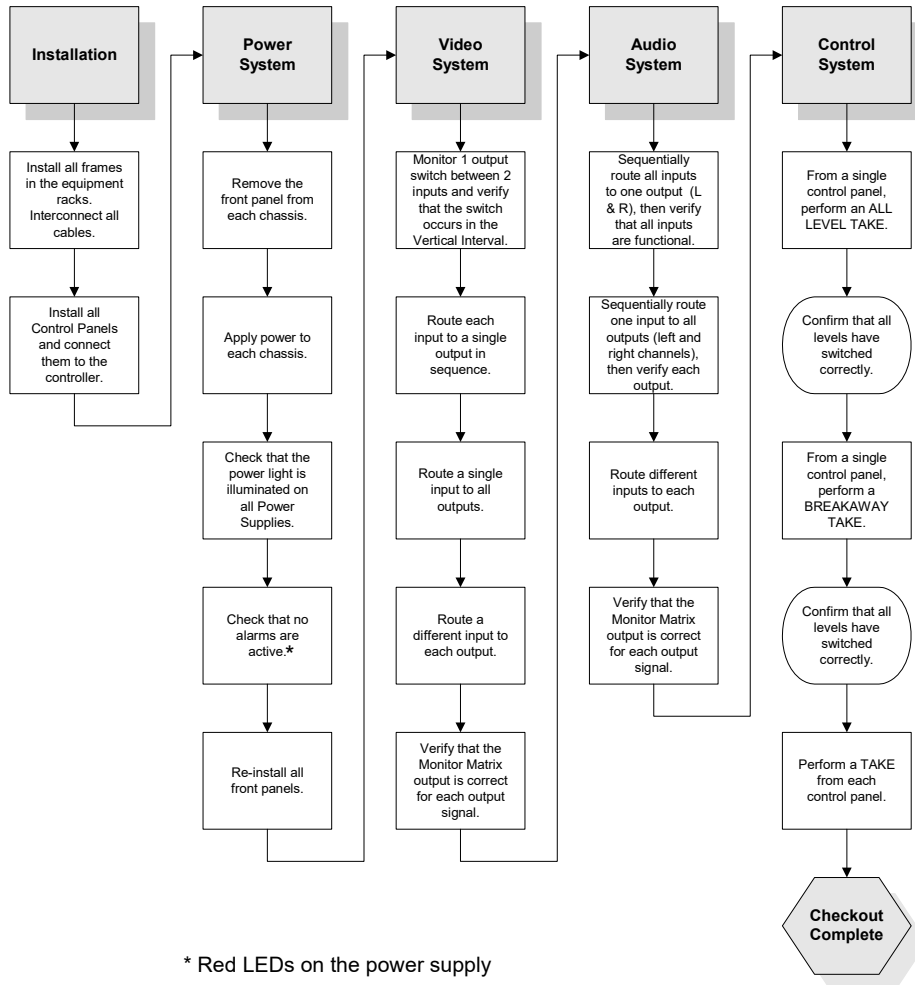

FIGURE 2-17. Crosspoint Fuse Location

Hardware Checkout

Use the following flow chart to check out your Utah-400 System. Note the following important points:

- For the Video and Audio System columns may be switched numerically if encoding is not required.
- For the System Control column, the SC-4 Control system may require some configuration in order to perform all functions.



Configuration and Operation

This chapter provides an explanation for specific Utah-400 configurations, and basic instruction for the handling and operation of your Utah-400 system.

In This Chapter

| | |
|---|-----|
| Utah 400 SC-4 Control | 3-2 |
| Operation | 3-4 |
| Input and Output Card Removal and Replacement | 3-4 |
| Crosspoint Card Removal and Replacement | 3-4 |
| Fan Service | 3-5 |
| Additional Notes (Service) | 3-6 |
| Power Supplies | 3-6 |
| Crosspoint Control (Cards) | 3-8 |
| Power Cord Retainer | 3-9 |

Utah 400 SC-4 Control

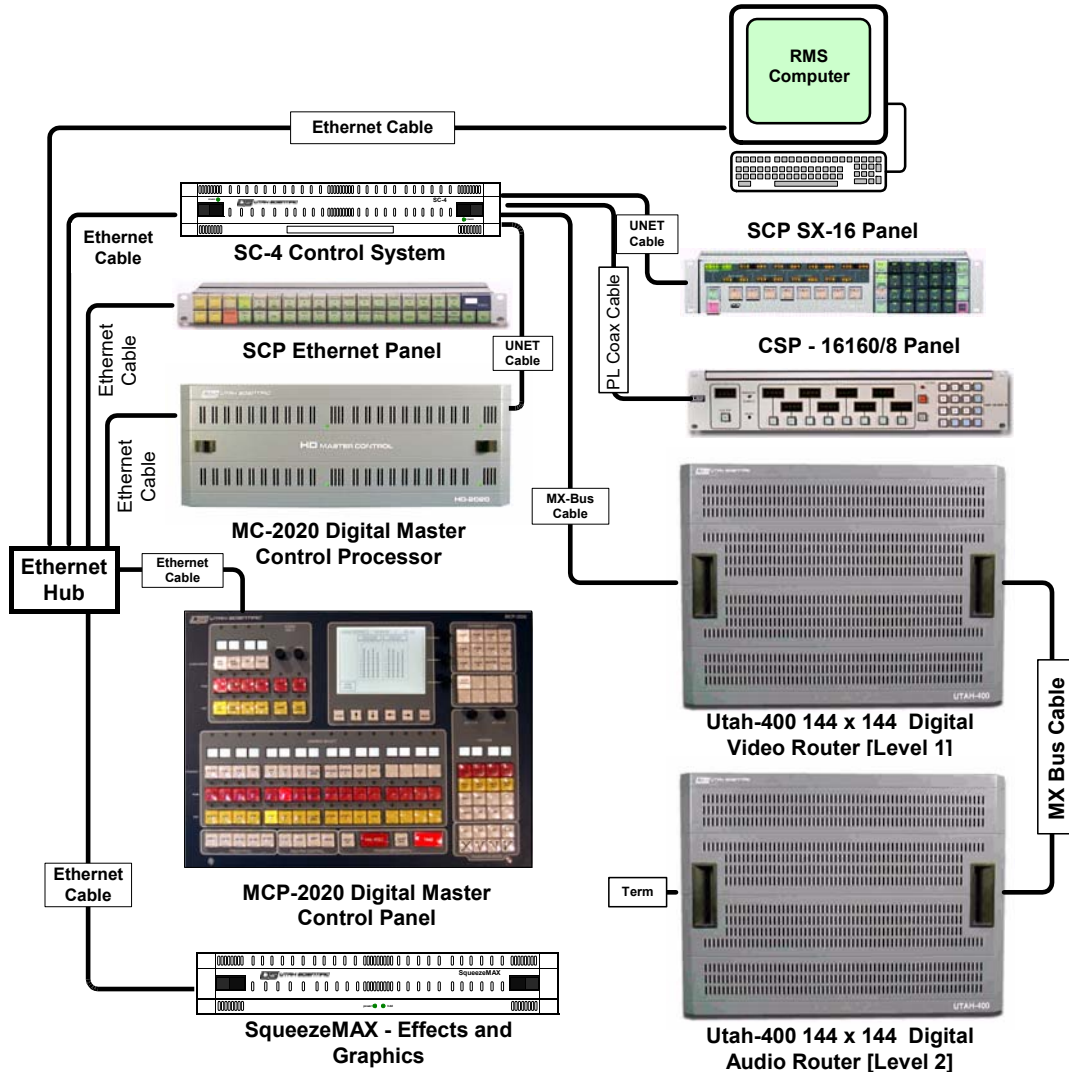

FIGURE 3-1. Utah 400 SC-4 for Utah-400 and MC/MCP-2020

TABLE 1. SC-4 Configuration for the Utah-400 and MC/MCP-2020

| SC-3/4 System Cable / Termination Table | | | |
|--|--------------------|---|-----------------|
| Part Name | Part Number | Description | Comments |
| UNET Terminator | 65324-04 | 8 RJ-45 | Supplied by USI |
| MX-Bus Terminator | 70797-1 | DB-25P Module | Supplied by USI |
| MX-Bus Cable | 80229-010 | Parallel / DB-25P | Supplied by USI |
| UNET Cable | N/A | UTP/RJ-45 | Not Supplied |
| Ethernet Cable | N/A | UTP/RJ-45 | Not Supplied |
| Party Line Coax Cable | N/A | Belden RG-59/U; 9209 or 8281 | Not Supplied |

Operation

Input and Output Card Removal and Replacement

To correctly remove and replace the individual input and output cards, always make sure the guides are located (inside the chassis) and the card slides all the way in before the ejector is locked in place. The card ejectors are pressed inward and down from the card when locking, and pulled outward from the card when removing.

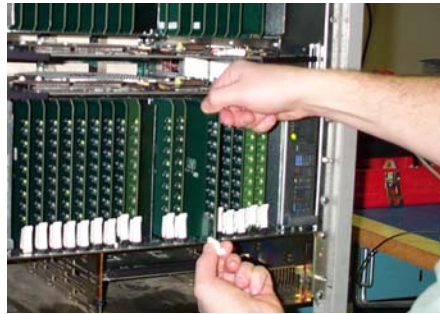

FIGURE 3-2. Input/Output Board Replacement and Removal

All boards within the Utah-400 system are hot-plug capable.

Crosspoint Card Removal and Replacement

The Crosspoint card uses a slightly different version of the locking and unlocking mechanism. The board is removed by gently pulling the ejector tabs outward, and locked into place by pressing the two tabs inward.

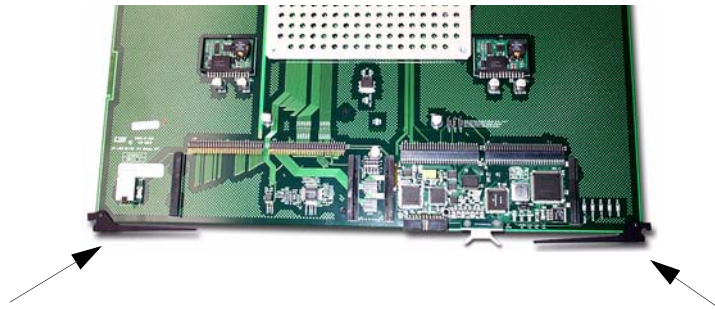

FIGURE 3-3. Crosspoint Board Replacement and Removal

Fan Service

Alarm indicators on the crosspoint control card and power supplies indicate fan problems. Individual fans can be removed and carefully disconnected using the small screws and mating connectors. Make sure the key is aligned properly when reconnecting.

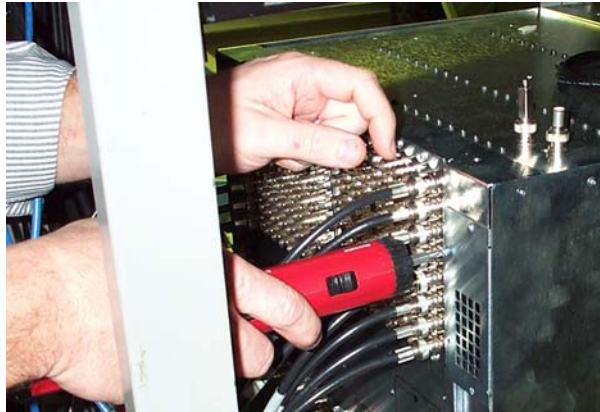

FIGURE 3-4. Fan location

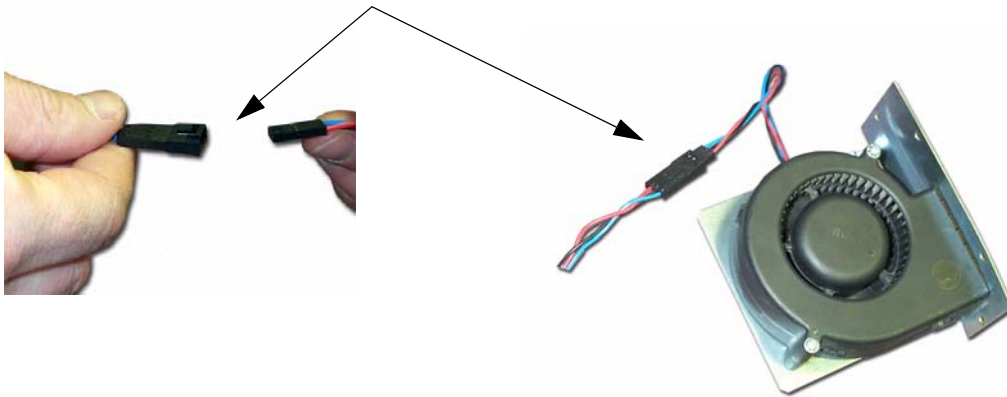

FIGURE 3-5. Fan Connection

Additional Notes (Service)

Power Supplies

The Power Supply is removed by using the thumbscrew.



There are two types of power supplies; the 'standard' and the Vicor, with each containing a unique voltage calibration. A re-calibration is advised whenever a power supply is added or replaced.



Standard Power Supply

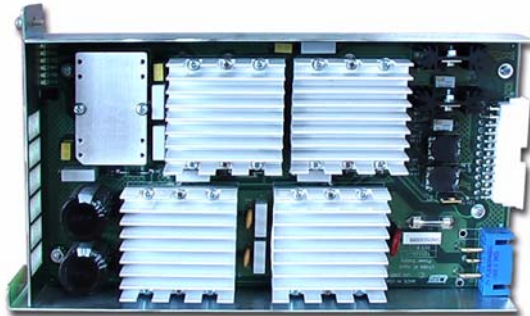

Vicor Power Supply

Additional Notes (Service)

Power supply voltage is measured at the central crosspoint (front of the chassis). Calibration is recommended when the power supply's voltage falls outside the acceptable range. Please contact Customer Service for specific voltage range recommendations.

When voltage calibration is needed, voltage adjustments are made by adjusting the small *pot* inside the supply.

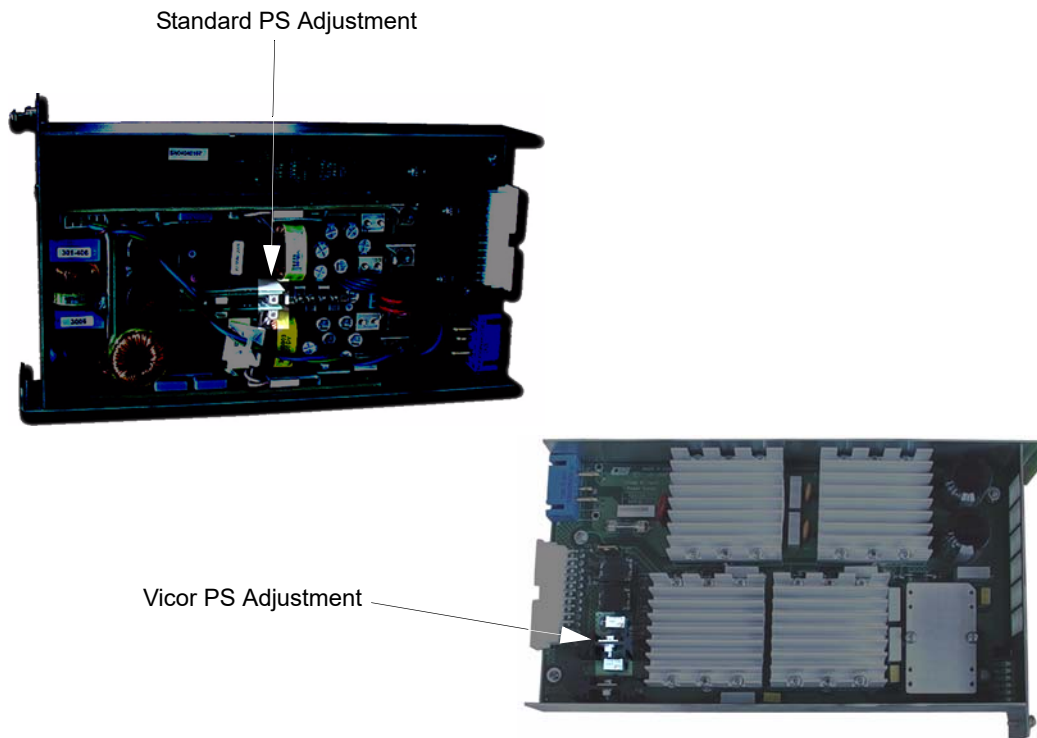

The standard supply is adjusted to within 3.3 volts, while the Vicor adjustment must stay within 5 volts.

Crosspoint Control (Cards)

The current crosspoint card (in use) is designated by the presence of the green FPGA ACT(ive) (LED).



The redundant crosspoint card is noted by the presence of the yellow SG ACTIVE (LED), as shown in the following illustration.

By pressing the Reset button (below), control is shifted to the opposite crosspoint card, with the LED pattern also changing to the alternate card.

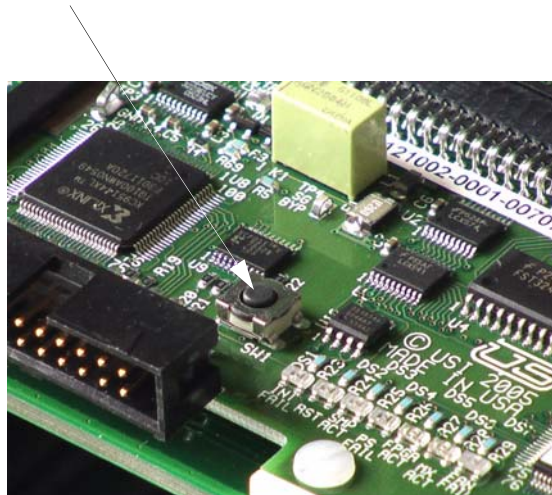

Power Cord Retainer

It is recommended that you use the supplied retainer for added stability.

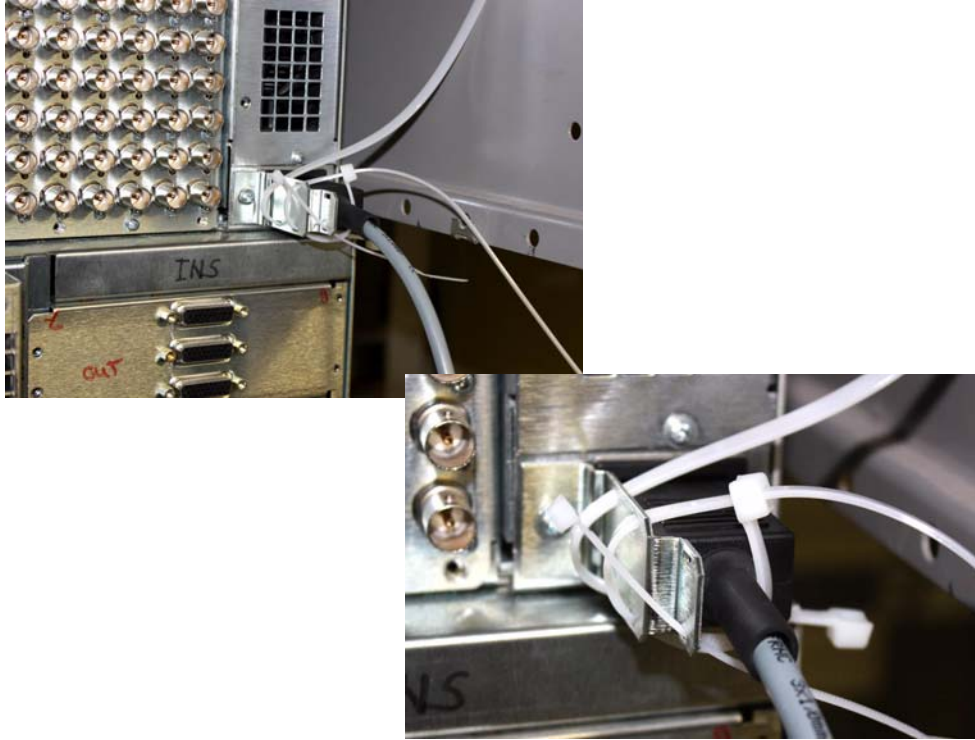

FIGURE 3-6.

Use tie wraps to hold the plug firmly in place.

In This Chapter

This chapter contains descriptions of each video and audio board type contained within the Utah-400; including Input, Output, Crosspoint and Interface (midplane) cards, and Power Supplies. Information regarding LED indications and alarms is also provided.

| | |
|---|------|
| Video Input Boards | 4-2 |
| Video Output Boards | 4-8 |
| Fiber Interface | 4-16 |
| Video Crosspoint Board (Redundant) | 4-20 |
| Interface Board (Midplane) | 4-25 |
| Power Supplies | 4-27 |
| Audio Input | 4-28 |
| Audio Output | 4-29 |
| Deluxe Output Board | 4-30 |
| Audio Crosspoint Board (Single Chassis version) | 4-38 |
| Crosspoint Card (Redundant 144 Audio Systems) | 4-45 |

Video Input Boards

SD Video Input

Part number 121016-1, the SD Video Input board contains 8 circuits that allow video to be received within the system. This card performs cable equalization prior to passing the signal input along to the crosspoints. This card is also limited to lower data rate Serial Digital Inputs.

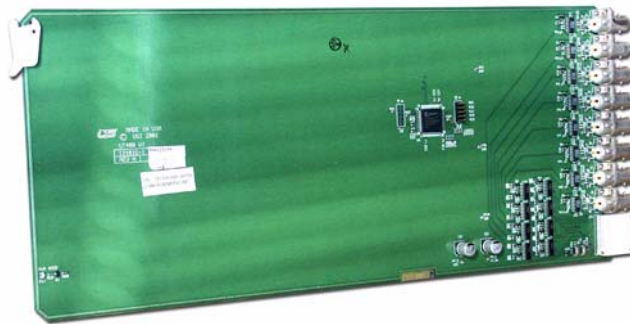

FIGURE 4-1. SD Video Input Board

Multi-Rate Input

Part number 121020-1, the Multi-Rate Input board is designed for High Definition Inputs, as well as Serial Digital Inputs.

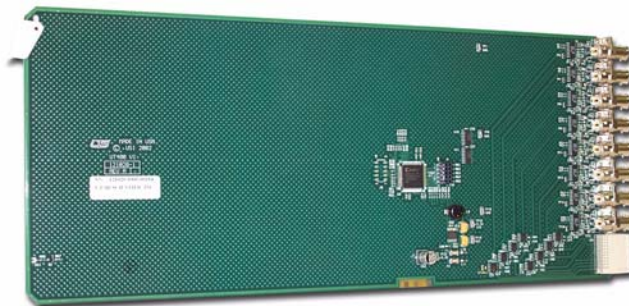

FIGURE 4-2. Multi-Rate Input Board

Analog to Digital

Part number 121045-1, the Analog to Digital board allows the input of analog video signals, then takes these signals and converts them to digital before presenting them to the Crosspoint card(s).

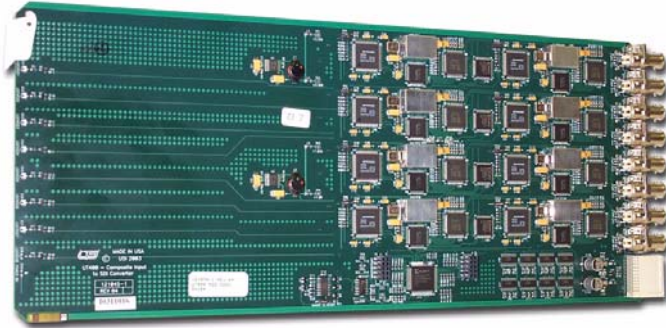

FIGURE 4-3. Analog to Digital Board

LED Indications

The SD Video Input and Multi-Rate Input cards only contain a ‘Power Good’ indication. This LED responds to the Utah-400’s two power supplies and illuminates if power is okay, and is not lit when power is absent.



FIGURE 4-4. Power Good LED

The Analog to Digital board contains the same Power Good indication as above, and also contains an LED for each input signal – green if the signal is present, and not illuminated to indicate signal absence.

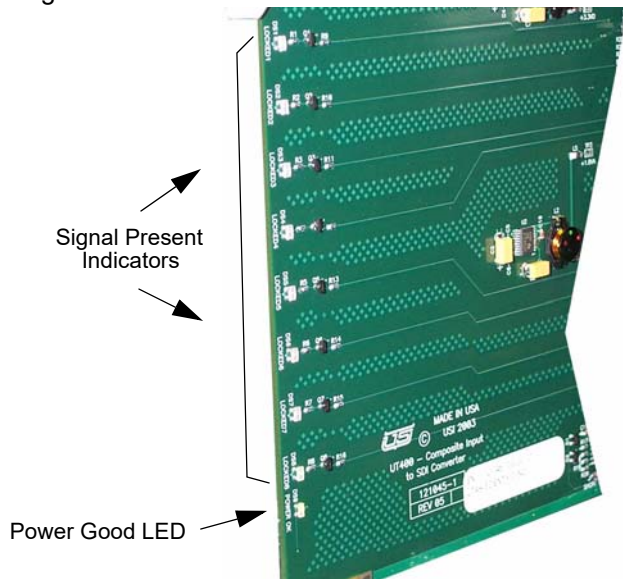

FIGURE 4-5. Analog to Digital card LEDs

Reclocking Input Expansion Card

Part #121125-1, the Reclocking Input Expansion card is used only in the output expansion stacks of the UTAH-400 1152x1152 series of routers. Instead of accepting serial digital or analog signals from rear panel mounted BNC connectors, [they] accept signals from the first output stack (0-287 outputs) through a custom 8-way interconnect cable. The card can process SD-SDI or HD-SDI signals, or analog signals that have been converted to SD-SDI in the first frame.

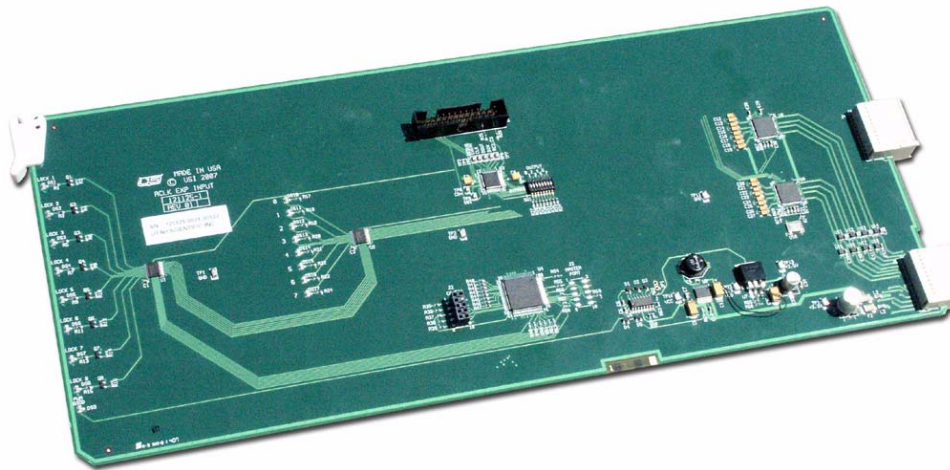

FIGURE 4-6. Reclocking Input Expansion card

Features

This card handles 8 channels of video; it receives, equalizes, and reclocks the video signals coming from the first frame, then distributes them to both the local frame's crosspoint and the midplane expansion output connector. This allows for a connection to another UTAH-400 output chassis stack. The card also has the ability to disable reclocking on individual inputs if desired, and contains an array of status LED's to indicate whether or not it has locked to a signal, and if so, that signal's rate.

Controls

The single control point on this card is dipswitch SW1, the bypass control. By moving one of the individual switches to the 'ON' position, the reclocker for that input is defeated. The dipswitch labeled 0 is for the lowest numbered input on the card, while 7 corresponds to the highest.

Indicators

There are 17 LED's located on the card, 8 correspond to the input signal lock status, 8 correspond to a rate indication, and one is a board power good indicator. DS9 is the power good indicator, and when lit, board power supplies are OK. If not lit, one or more of the supplies on the board have failed.

DS1-8 are locked indicators for the 8 inputs on the board. DS1 corresponds to the lowest input number, while DS8 corresponds to the highest. ON indicates that this particular input is present and is being reclocked. A dark LED means the signal is not present. Please note that if the reclocker is bypassed, the corresponding LED will be dark.

DS10-17 - (text to follow)

Specifications

Power Consumption - 4.25W

Reclocker Rates - SMPTE-259CD and SMPTE 292. The card must be manually bypassed for any other rates.

UTAH-400 3G Input Card

Part #121170-1 the UTAH-400 3G Input card contains 8 inputs that accept SDI signals. There are two versions of this card; identified by a -1 or a -2 in the serial number. The -2 version is capable of receiving all SDI signals up to the SMPTE-424 1080P standard. The -1 version contains a maximum data rate of HD-SDI, the SMPTE-292 standard.

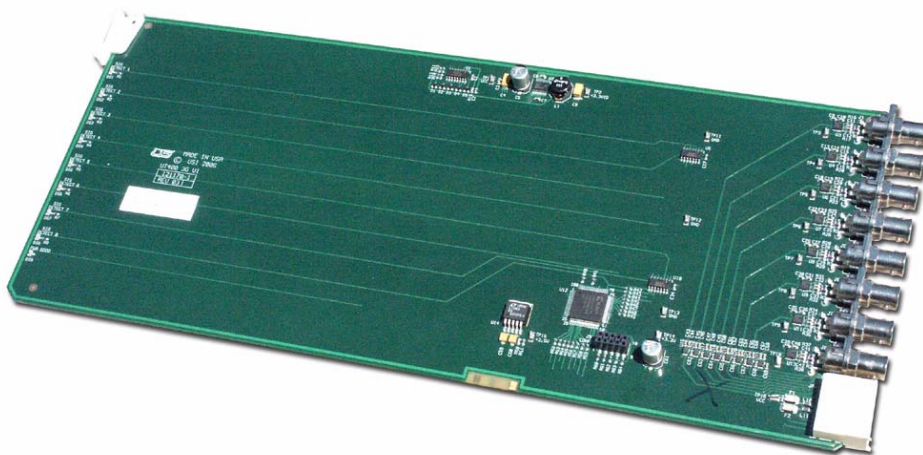

FIGURE 4-7. 3 Gig Input card

Features

The card handles 8 channels of video; receiving and equalizing the video signals coming from the 8 rear panel mounted BNC connectors, then distributing them to both the local crosspoint (in the frame) and to the midplane expansion output connector, allowing for connections to an additional UTAH-400 output chassis stack. The card also contains an array of status LED's to indicate if it has acquired the carrier of a SDI signal.

Controls

None

Indicators

There are 9 LED's located on the card; 8 used for input signal carrier status, and one used for the 'power good' indication.

DS9 is the power good indicator, and when lit, all board power supplies are OK. When not lit, one of more of the supplies on the board have failed.

DS1-8 are carrier indicators for the 8 inputs on the board. DS1 corresponds to the lowest input number, while DS8 corresponds to the highest. ON indicates that this particular input is present. A *dark* LED means the signal is not present.

Specifications

Power Consumption - 3W

Cable EQ CApability

TABLE 1.

| | |
|------------------|---|
| SD-SDI SMPTE259 | 350 Meters of 1694 Cable |
| HD-SDI SMPTE-292 | 140 Meters of 1694 Cable (-2 version) 200 meters (-1 version) |
| 3G SDI SMPTE 424 | 100 Meters of 1694 Cable |

Video Output Boards

The Utah-400's Video Output cards receive signals from the Crosspoint card, where user specified switching takes place. All three card types (below) perform a signal presence detection, while the SD and HD Output cards contain a re-clocking stage.

SD-Output

Part number 121015-1, this card is used only for data rates that are within the standard definition range – up to approximately 540MHz per second. The SD output card is capable of passing 5 specific SMPTE data rates, with any other signal muted. This card will not pass non-standard video signals.

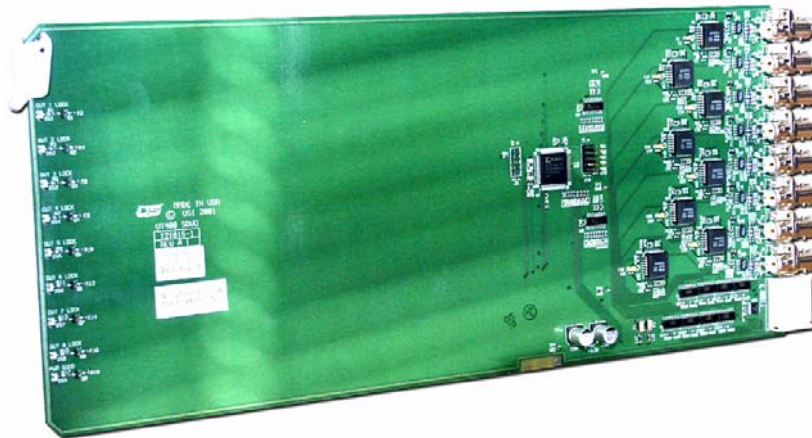

FIGURE 4-8. SD Output Board

HD-Output (Multi-Rate output card)

Part number 121019-2, the HD-Output card is capable of re-clocking at all SD and high-definition frequencies. Though non-standard video signals will not be re-clocked by this card, these signal types will be passed without muting.

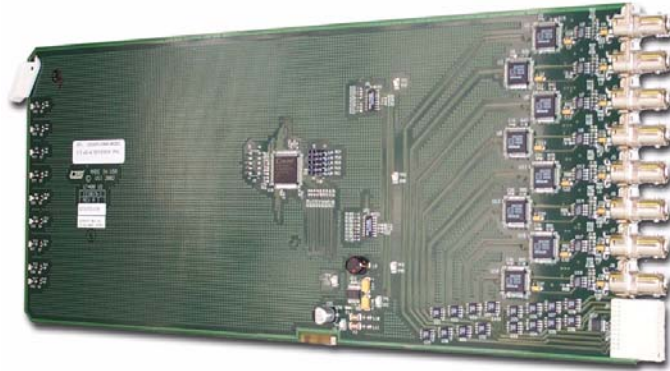

FIGURE 4-9. Multi-Rate Output Board

This board contains 1 dipswitch (per channel). The dipswitch will enable or disable the re-clocking mechanism.

Digital Video to Analog Converter Output card

Part number 121046-1, the Digital Video to Analog Converter card takes a standard 270 Megabit serial digital signal, then converts it to analog video before presenting it to the output.

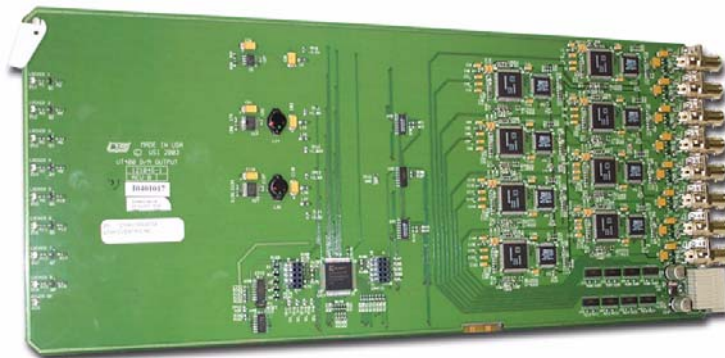

FIGURE 4-10. Digital to Analog Output Card

LED Indications

The Video cards contain a 'Power Good' indication. This LED responds to the Utah-400's two power supplies and illuminates if power is okay, and is not lit when power is absent.



FIGURE 4-11. Video Output Power Good LED

The SD/HD Video Output cards and the Digital to Analog card contain a Power Good indication, and also contain an LED for each output signal – green if the signal is present, and not illuminated to indicate signal absence.

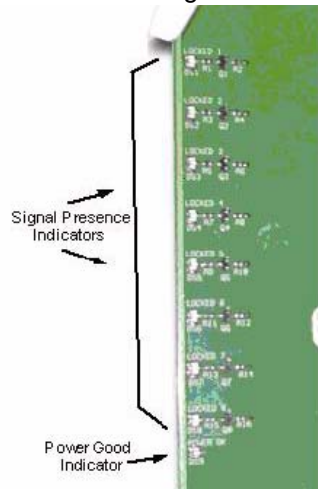

FIGURE 4-12. SD/HD Video Output and Digital Video to Analog LED Indicators

Multi-Rate Output Board

Overview

The Multi-Rate output card is capable of passing signals from between 3 Mb/Sec. to 1.5Gb per second. This card contains all of the features of earlier UT400 output cards at a lower cost and power consumption, with also some enhanced diagnostic and control facilities. This card occupies a single 8-output slot in a UT-400 64, 144, or 288 system.

Status Description

There are three sets of diagnostic LED's on the Multi-Rate Output card.

- First, DS9 (Power OK) is a very simple indication that both on-board power supplies are running.
- Second, DS1-DS8 are indications that the re-clocker chip has an active lock on the signal a particular channel is passing. These LED's will be off when either there is no signal passing through a given output or that channel has been manually bypassed.

- Thirdly, DS17-DS10 represent a status array that indicates what data rate the re-clocker (if locked) is actually locked to.
 - DS15-DS17 represent a three bit indication of the output number. The following table indicates the state of these LED's for the various outputs.

| Output | DS15 | DS16 | DS17 |
|--------|------|------|------|
| 0 | OFF | OFF | OFF |
| 1 | OFF | OFF | ON |
| 2 | OFF | ON | OFF |
| 3 | OFF | ON | ON |
| 4 | ON | OFF | OFF |
| 5 | ON | OFF | ON |
| 6 | ON | ON | OFF |
| 7 | ON | ON | ON |

DS10-DS12 represent a 3-bit data rate indication

| Rate | DS10 | DS11 | DS12 |
|----------|------|------|------|
| None | OFF | OFF | OFF |
| 270 Mb/S | OFF | ON | OFF |
| 360 Mb/S | OFF | ON | ON |
| 540 Mb/S | ON | OFF | OFF |
| 1.5 Gb/S | ON | OFF | ON |

These LEDs change at about a 1 second rate, giving you status of all of the re-clockers in about seven seconds.

If the onboard MPU cannot access the re-clocker chips to control them, DS10-DS17 will be set in a '55' pattern to indicate a communication problem.

Control Description

The Multi-Rate card has a single dipswitch, SW1, which enables or disables each of the 8 reclockers. When the dipswitch for a given output is set to the 'Reclock' position, the re-clocker will continually hunt for one of the following rates -- 270 Mb/Sec. (SMPTE 259M), 360 Mb/Sec. (SMPTE 259 Wide Screen), 540 Mb/Sec. (SMPTE 344) or 1.485 Gb/Sec. (SMPTE292). When it finds one of these data rates, it will lock to it and re-time the data to reduce jitter. If it loses lock, it will continue the process of hunting for the next data rate.

If the switch is set to 'Bypass', the re-clocker will not re-time the data, it will simply pass it from it's input to it's output. This is the preferred setting for any rate other than one of the ones listed above.

UTAH-400 3G Output Board

Part # 121171-1, the eight output, 3G Output Board can reside in any model of UTAH-400 router and is capable of reclocking and transmitting SDI signals. It comes in two different versions; the 121171-2, which covers data rates from SMTE-259, 292, and 424, and the 121171-1 version that covers data rates for SMPTE 259 and 292. The version of the card is determined by the -1 or -2 on the serial number sticker.

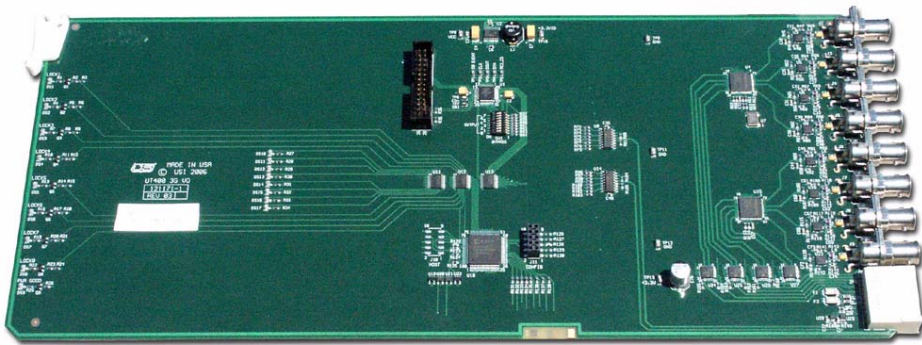

FIGURE 4-13.

Features

Handling eight channels of video, the card receives, equalizes, and reclocks the video signals coming from the local crosspoint card. These signals are then directed to a monitor matrix via the rear panel mounted BNC's. The card has the ability to disable reclocking on individual outputs if desired, and also contains an array of status LED's to indicate a signal lock, and if present, that signal's rate.

Controls

The single control point on this card is dipswitch SW1, the bypass control. By moving one of the individual switches to the 'ON' position, the reclocker for that input is defeated. The dipswitch labeled 0 corresponds to the lowest numbered input on the card, while 7 corresponds to the highest.

Indicators

There are 17 LEDs located on the card; 8 are designated to input lock status, 8 are designated for a rate indication, and 1 is a board power good indicator.

DS9 is the power good indicator. When lit, board power supplies on the board are OK. If this indicator is not lit, one or more of the supplies on the board have failed.

DS1-8 are locked indicators for the 8 outputs on the board. DS1 corresponds to the lowest output number, while DS8 corresponds to the highest. ON indicates that this particular output is present and is being reclocked. A dark LED means the signal is not present. Please note that if the reclocker is bypassed, the corresponding LED will be dark.

TABLE 2.

| DS 15-17 is the output indicator | | | |
|---|-------|-----|-----|
| OT | DS 15 | 16 | 17 |
| 0 | OFF | OFF | OFF |
| 1 | OFF | OFF | ON |
| 2 | OFF | ON | OFF |
| 3 | OFF | ON | ON |
| 4 | ON | OFF | OFF |
| 5 | ON | OFF | ON |
| 6 | ON | ON | OFF |
| 7 | ON | ON | ON |

| DS 10-12 is the data rate indication | | | |
|---|-------|-------|-------|
| Rate | DS 10 | DS 11 | DS 12 |
| Unlocked0 | | | |
| 270 Mb | OFF | ON | OFF |
| 360 Mb | OFF | ON | ON |
| 540 Mb | ON | OFF | OFF |
| 1.485 Gb | ON | OFF | ON |
| 3.0 Gb | ON | ON | OFF |

Specifications

Power Consumption - 6.5W

Reclocker Rates - SMPTE-259CD, SMPTE 292 and SMPTE-424 (-1 Version Only). Card must be manually bypassed for any other rates.

Fiber Interface

Utah 400 systems with fiber connectivity will contain dedicated input and output boards for this purpose. Instead of using BNCs for the physical connection, the system utilizes small modules that plug directly into the rear of the UT-400 chassis.

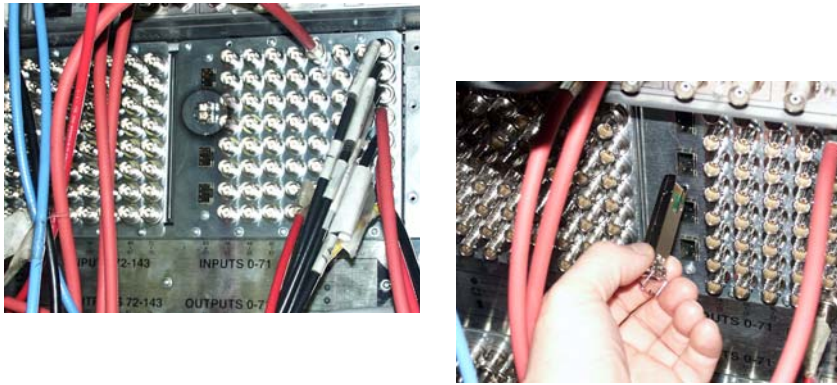

FIGURE 4-14. Module location and removal

The Input and Output board's LEDs are identical in functionality to their Multi-Rate Input and Output counterparts. (For more detail, see Fiber LED Indications - 4-13.)

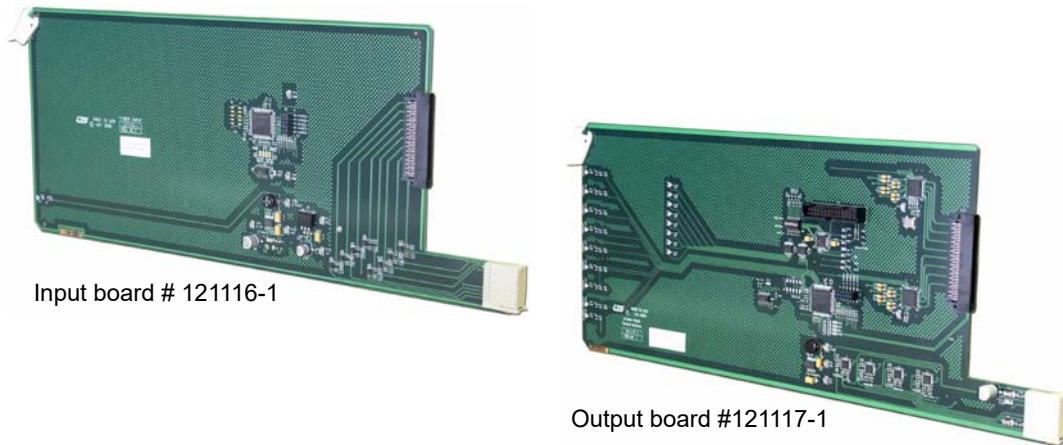

FIGURE 4-15. Input and Output boards

The small modules are responsible for the electrical-optical conversion, and are removable if service is required.



FIGURE 4-16. SP2T - Transmitter module

The SP2R is the receiver module, and is a part of the larger Input card assembly. The SP2T is the transmitter module, and makes up the Output card assembly. These modules are removed and replaced by moving the swinging bale (at the end) out of, and back in to the locked position.

The system's input and output *totals* are typically defined prior to equipment setup and operation. This is based on the number of total fiber inputs.

Specification Detail

- Optical Fiber Output – 1310 nm class 1 laser.
- Optical Output Power - -12dB minimum
- Optical Fiber Type – 9/125 uM Single Mode Fiber
- Connector Type - LC
- Typical Cable Length – 18 Miles SD, 10 Miles HD
- Optical Fiber Input – 1310 nm Class1 laser
- Optical Input Power - -20dB min
- Optical Fiber Type – 9/125 uM Single Mode Fiber
- Connector Type - LC
- Typical Cable Length – 18 Miles SD, 10 Miles HD

Fiber Output LED Indications

There are three sets of diagnostic LED's on the Multi-Rate Output card.

- First, DS9 (Power OK) is a very simple indication that both on-board power supplies are running.
- Second, DS1-DS8 are indications that the re-clocker chip has an active lock on the signal a particular channel is passing. These LED's will be off when either there is no signal passing through a given output or that channel has been manually bypassed.
- Thirdly, DS17-DS10 represent a status array that indicates what data rate the re-clocker (if locked) is actually locked to.
 - DS15-DS17 represent a three bit indication of the output number. The following table indicates the state of these LED's for the various outputs.

| Output | DS15 | DS16 | DS17 |
|--------|------|------|------|
| 0 | OFF | OFF | OFF |
| 1 | OFF | OFF | ON |
| 2 | OFF | ON | OFF |
| 3 | OFF | ON | ON |
| 4 | ON | OFF | OFF |
| 5 | ON | OFF | ON |
| 6 | ON | ON | OFF |
| 7 | ON | ON | ON |

DS10-DS12 represent a 3-bit data rate indication

| Rate | DS10 | DS11 | DS12 |
|----------|------|------|------|
| None | OFF | OFF | OFF |
| 270 Mb/S | OFF | ON | OFF |
| 360 Mb/S | OFF | ON | ON |
| 540 Mb/S | ON | OFF | OFF |
| 1.5 Gb/S | ON | OFF | ON |
| 3.0 Gb/S | ON | ON | OFF |

These LEDs change at about a 1 second rate, giving you status of all of the re-clockers in about seven seconds.

If the onboard MPU cannot access the re-clocker chips to control them, DS10-DS17 will be set in a '55' pattern to indicate a communication problem.

Fiber Operation at 3 Gb/Sec.

The 121116-2 Input and 121117-2 Output cards that are revision B or later are capable of 3 Gb/Sec. SMPTE-424 operation. They must be used in conjunction with the Genum G02920 Dual Optical Receiver (input) or the Genum G02922 Dual Optical Transmitter (output) in order to be SMPTE-424 compliant.

If the boards are used with the SP2R receiver or SP2T transmitter, they will work fully with signals up to HD-SD1 SMPTE 292, but not with 3G-HD signals.

Video Crosspoint Board (Redundant)

Part number 121013-1, the Redundant Video Crosspoint board contains 144 inputs and 144 outputs with a crossbar array in the middle. The Crosspoint board receives signals through the midplane from the 18 input cards, while switching is carried out by a single crosspoint chip located underneath the heat sink. After the signal is switched, it is again routed through the midplane to the output boards.

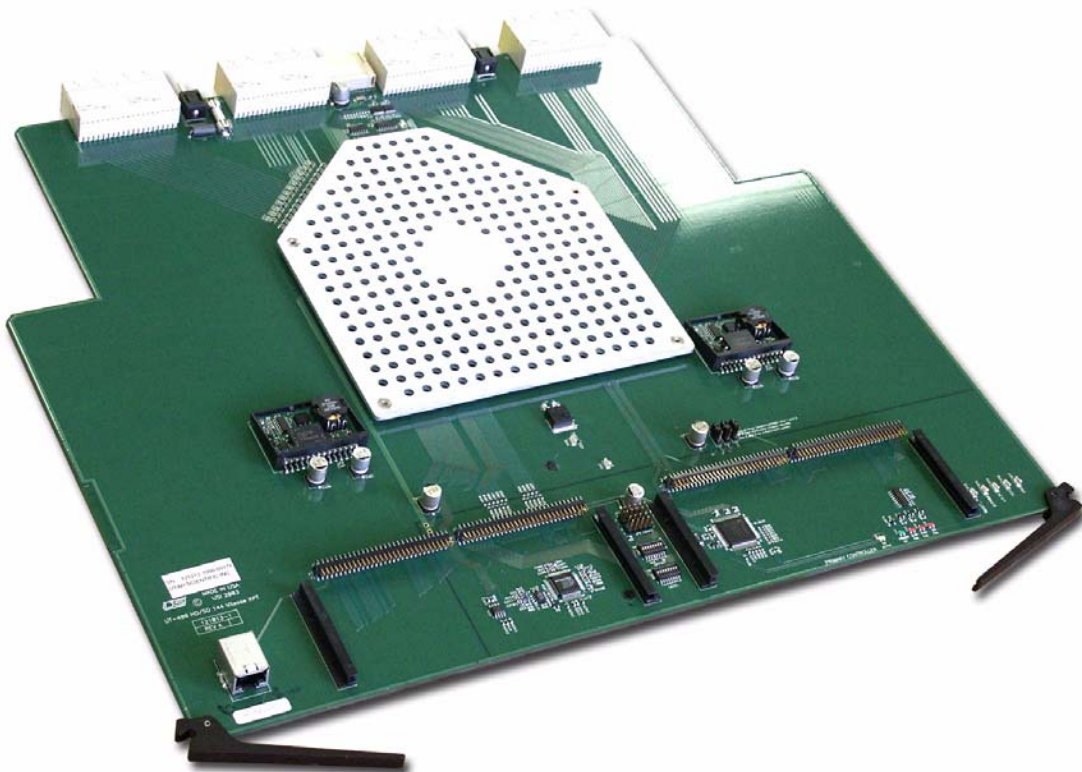

FIGURE 4-17. Video Crosspoint Board (Redundant)

User Controls

The dip switches located on the crosspoint card are used to set the input and output offset level. This corresponds to the differing audio and video levels as applied to SD video or HD video, which may need to be switched separately. The dip switch settings allow the control of the video router independently of the audio router when necessary. Specific dip switch settings are addressed in the Hardware Installation section – Figure 2.9.

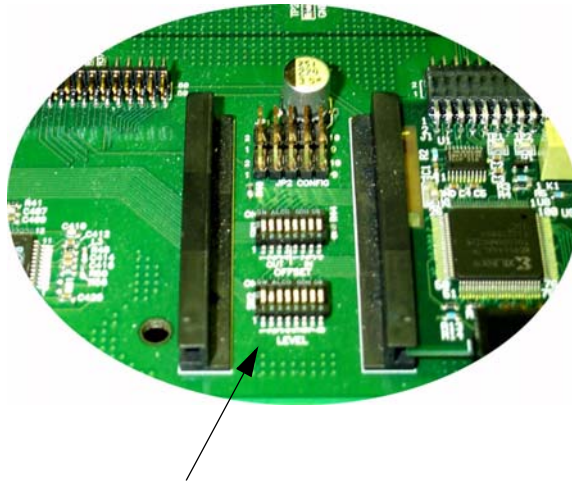

FIGURE 4-18. Video Crosspoint Dip Switches

Indicators

Power Ok LED

The green LED is illuminated when all supplies are normal and functioning.

Voltage Failure Mode (3 LEDs)

In this mode, one of the red LEDs will illuminate while the green 'normal' LED turn off.

Scan Data Active (LED)

The yellow LED pulses continuously when conditions are normal. A solid LED indicates the 'standby' crosspoint in a redundant system.

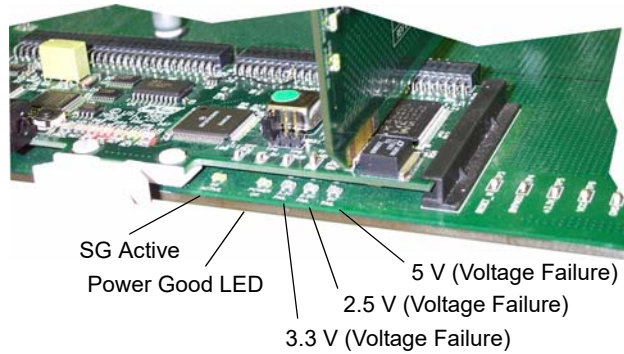

FIGURE 4-19. Video Crosspoint LEDs

FPGA Control Board

The Crosspoint control module decodes the incoming information delivered through the MX bus cable. The module queries the power supplies for status determination, and samples the tachometer for the chassis' 4 cooling fans. The crosspoint control module also contains a contact closure that is used to identify error conditions associated with crosspoint card's SMPTE alarm.

This module is part of a redundant pair, with the right hand module acting as the default primary card in single crosspoint systems.



FIGURE 4-20. Video Crosspoint control Module

Crosspoint Control Module LED Indications

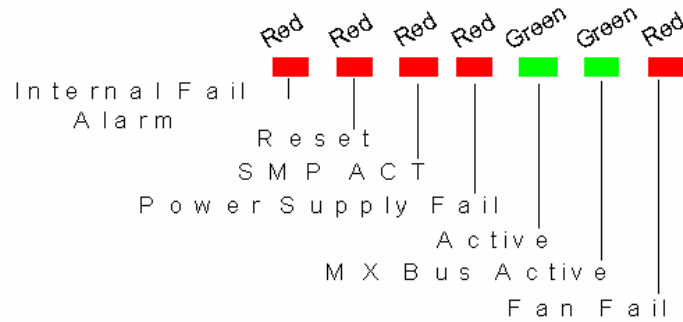

Internal Fail Alarm (Red)

Lit when the card is experiencing a problem with its internal power supplies.

Reset (Red)

Indicated when the card is in a stand-by mode.

Power Supply Fail (Red)

Indicates a problem with one of the UT-400's power supplies.

Active (Green)

Indicates the current card is 'active' when lit.

MX Bus Active (Green)

Data is being received correctly.

Fan Fail (Red)

Indicates a problem with one if the four cooling fans.

Note: In redundant systems, all red LEDs flashing (at the same rate) on a given crosspoint card indicates standby (or inactive) status.

Board Jumpers

The video crosspoint card contains three jumper blocks, with pins 1 and 2 used for non-redundant chassis. A redundant chassis will contain two crosspoint cards, with the pins moved to the 2 and 3 positions. When in this mode the crosspoint control module must reside in the right-hand (primary) slot, and no module can occupy the left-hand slot.

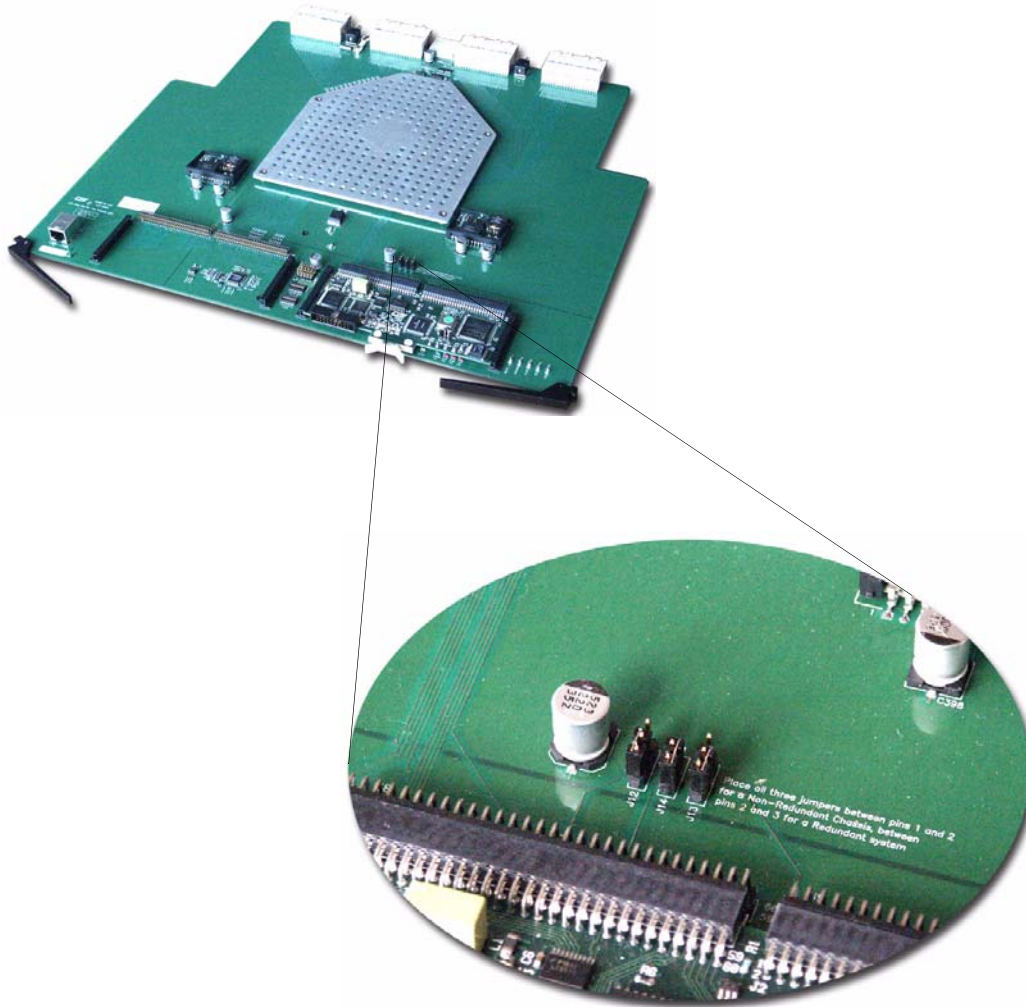

FIGURE 4-21. Video crosspoint module jumper location

Interface Board (Midplane)

The Interface board is a completely passive device located at the rear of the chassis. All card elements inner-connect at this location.



FIGURE 4-22. Video Midplane

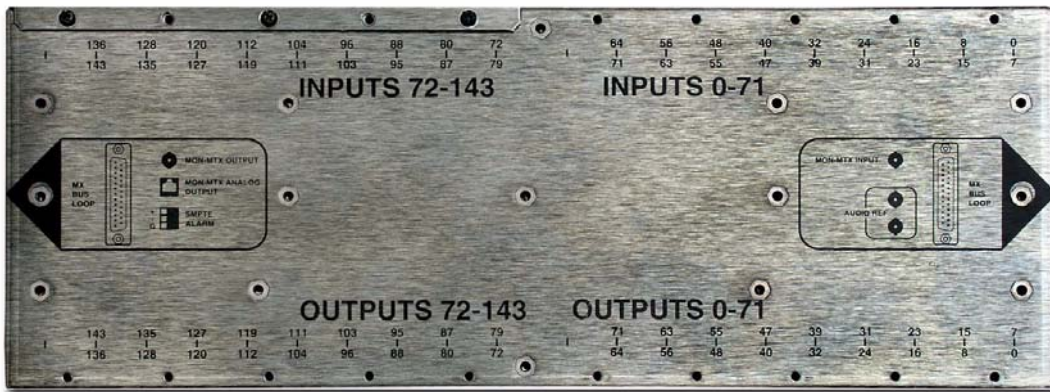

FIGURE 4-23. Redundant Midplane

Part Description

MX Bus (control bus)

This is the control bus between the UT-400 and an SC-3/4 controller. Each chassis contains two connectors, fed through either side, then distributed to the next piece of equipment from either side. If this router is at the end of the run (cable), a termination is inserted at the unused side.

Monitor Matrix function

This allows the user to switch up an additional output that can look at the output of any other output modules present in the system. The Monitor Matrix input is located on the left side of the chassis, while the output is located on the right side.

BNC Connection (Midplane)

Two additional midplane BNC connectors are used for loop through for the AES reference signal. These two BNCs are essentially interchangeable (middle and lower connection). A reference signal is applied to one while the same signal is derived out the opposite one (otherwise terminated). The Time Base sub-module's synchronization reference is applied at this location.

RJ-45 Connection

This is used to derive analog monitor matrix functionality. To support this, the system will contain a monitor matrix satellite sub-module that converts the native digital audio format to analog outputs, and will then distribute a signal to this connector. Not in service at this time.

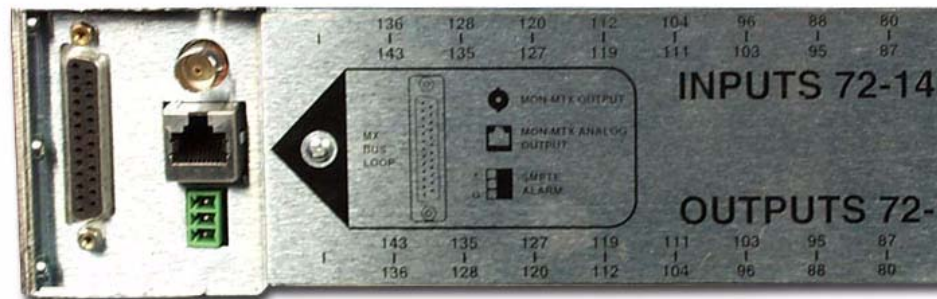

FIGURE 4-24. Audio Midplane's RJ-45 connection

Power Supplies

The Utah-400's power supplies are standard, with AC input, alarm monitoring circuitry, and DC output going to the system.

LED Indications

If no alarms are present, all indicator LEDs will be off while the large green LED at the bottom is green.

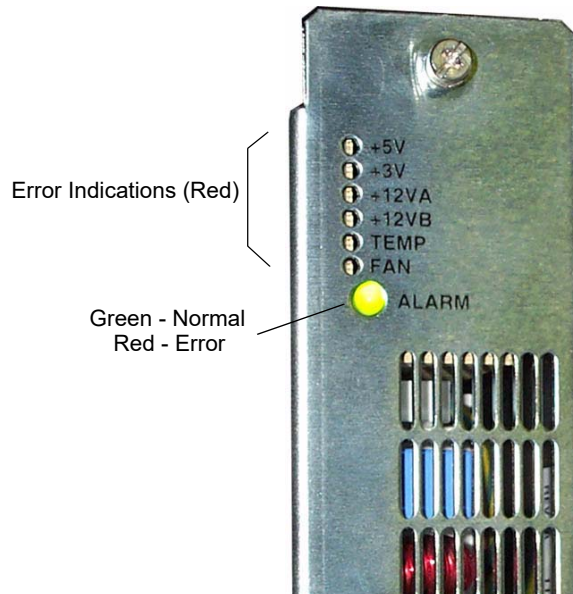

FIGURE 4-25. Power Supply

Individual supply alarms will be indicated with the corresponding red LED. Specific adjustments are available for individual voltage indications within this guide's Troubleshooting section.

The LED is viewable on the front cover through the lightpipe.

Audio Input

Audio Input Board

Part number 121026-1, the Audio Input board contains 8 circuits that allow audio to be received within the system. This card contains 8 LED indicators, which correspond to the 8 individual input channels that the card processes. The 9th LED indicator is used for local power monitoring, while the 10th indicator (Program Done) illuminates when a download has properly occurred.

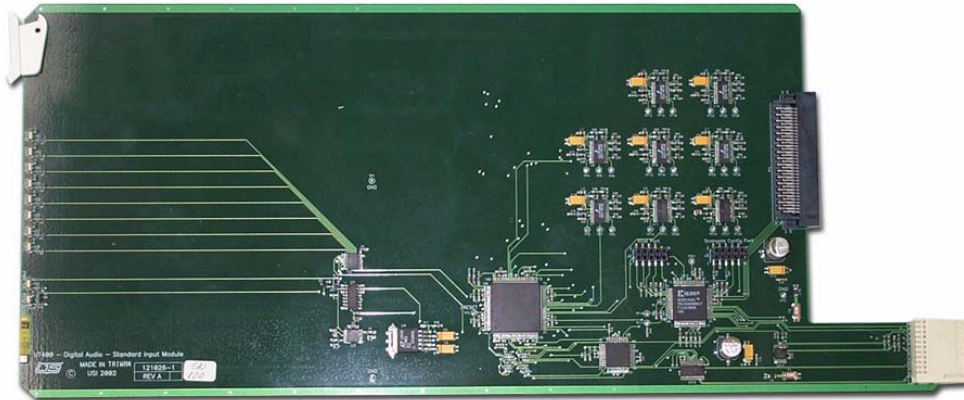

FIGURE 4-26. Audio Input Card

Audio Output

Audio Output Board

Part number 121027-1, the Audio Output board contains 8 circuits that allow audio to be distributed to the backplane. This card contains 9 LED indicators, 8 of which correspond to channel activity. The 9th LED indicator (offset from the others) is the board's Power OK indicator.

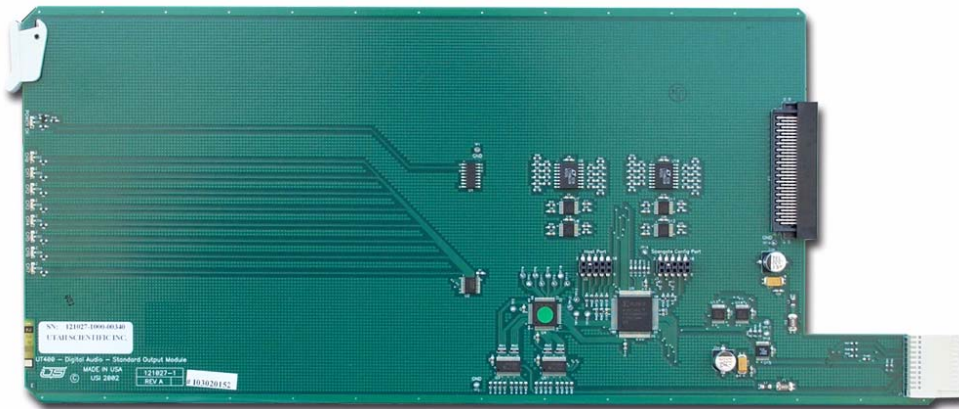

FIGURE 4-27. Audio Output Card

Two rear panel configurations for this card are available; one for balanced operation and one for unbalanced operation.

Deluxe Output Board

This card is capable of performing Audio Fades, typically as switching is done from one source to another.

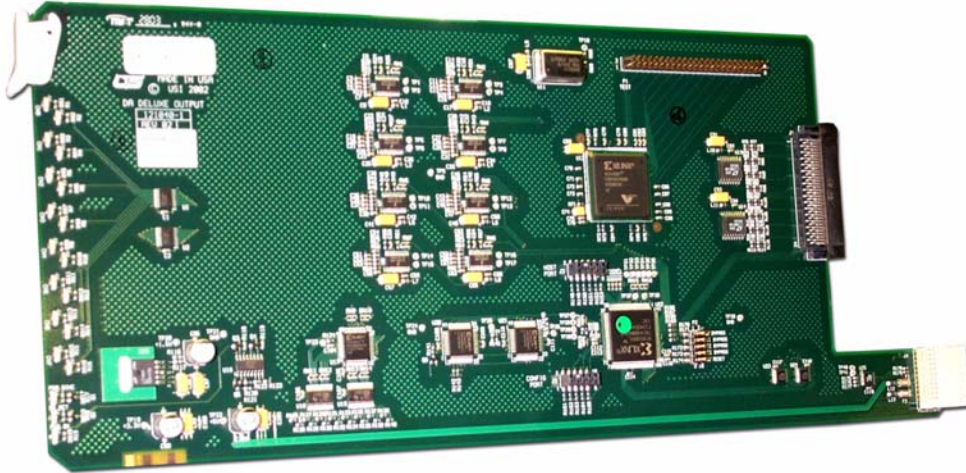

FIGURE 4-28. Deluxe Audio Output Card

Accomplished during the switch, the audio fade feature suppresses any pops or clicks that may potentially be present if the fade did not occur.

This card contains a larger array of input indicators; with two associated with each of the 8 channels processed on the board.

Deluxe Output Board

Board Indicators

There are two indicators per channel; green to indicate signal presence, and red to indicate any defect in the signal. A defect typically exists when certain signal formats are non-standard.

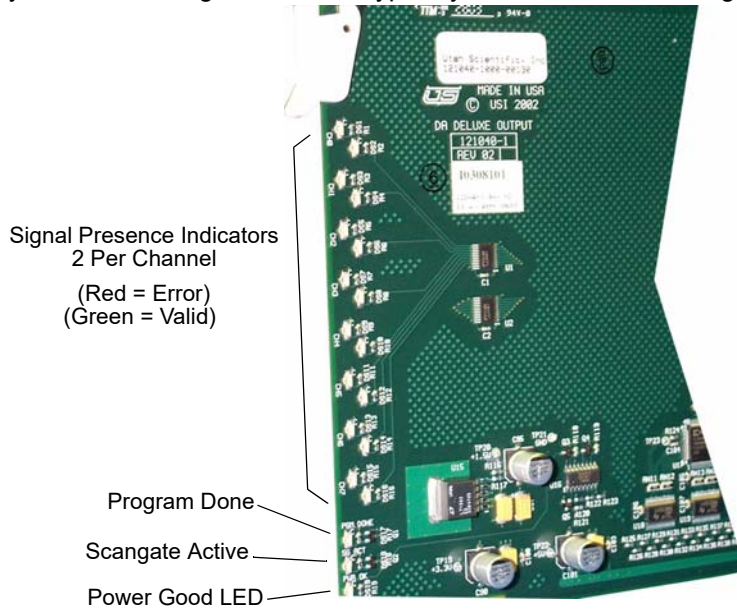

FIGURE 4-29. Deluxe Audio Output Card

The Deluxe output card contains a Power Ok indication, and a Program Done indication.

The SGACT (Scangate Active) LED indicates a successful communication between the host processor on the crosspoint board and the actual output board. The Program Done and Power LEDs should be on, while the Scangate Active LED flashes continuously.

The Deluxe Output board mates up with the same I/O adaptors as the standard card, allowing the mixing of different balanced or unbalanced cards within the same chassis.

Deluxe Output Module

This circuit module, USI 121040-1, is an alternate output module for the Utah-400 digital audio router with capability to modify the payloads of the eight AES-formatted digital audio signals that it conveys.

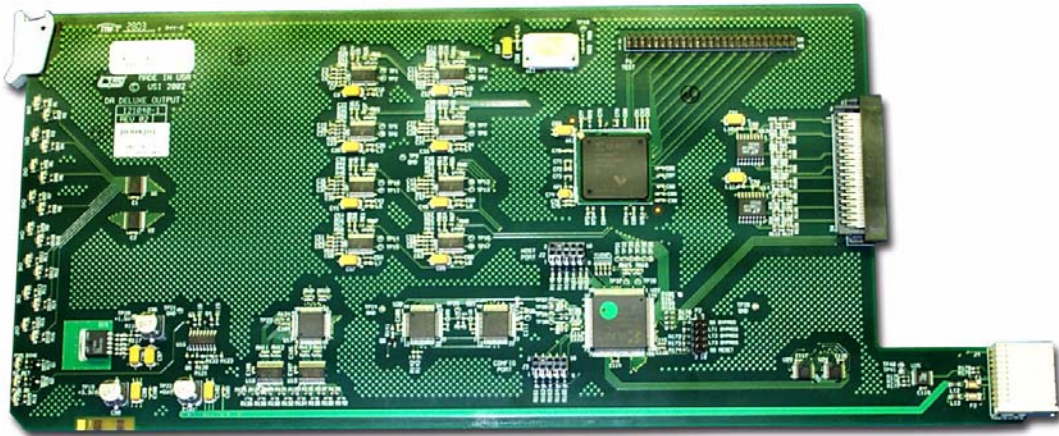

FIGURE 4-30. Deluxe Output Module

These capabilities include the following:

- Execution of a V-fade that ensures clickless synchronous switching of outputs by first fading-down the previous source from full to zero amplitude, performing a synchronous source switch, then fading-up the new source from zero to full amplitude.
- Execution of analog-like channel data manipulations:
 - Channel swap
 - Channel 1 to both output channels
 - Channel 2 to both output channels
 - Selective polarity (phase) inversion of channels
 - Selective muting of channels
 - Summation of channels to monaural ($[L+R]$, $-[L+R]$)
 - Summation of channels to difference signals ($[L-R]$, $[R-L]$)
- Adjustment of output word lengths to 16, 20, or 24 bits at user discretion.

Addition of dither to output signals at user discretion.

These capabilities are accessed by control and status monitoring via embedded JTAG control structures included in the Utah-400 router platform.

Further, these operations are performed in concert with the channel status (C-bit) indications at the inputs, and the channel status outputs are set appropriately, according to parameters from inputs and commanded functions.

This module also includes the provisions present on the standard output module (USI 121027-1), i.e. signal presence detection, protection input switching capability, and monitor matrix functionality.

In order to properly perform its intended function, the V-fade facility is expected to operate on signal sources that are synchronous to the router's DARS (digital audio reference signal). If either (or both) the pre- or post-switch sources are asynchronous, the hardware will still execute the commanded V-fade operation, but at the switching point, it will have to acquire the frequency and phase of the new signal, outputting an improper discontinuous AES signal while it does so. Since there can be no possible guarantees of the responses of downstream equipment, this mode of operation is not recommended and should be avoided.

All other signal manipulations are suitable for both synchronous and asynchronous AES sources.

This module is substituted for the standard output module in a Utah-400 chassis, on an as-needed basis; to bring these enhanced features to those specific system outputs.

DAC Output Module

This circuit module, USI 121041-1, is an alternate output module for the Utah-400 digital audio router that delivers analog output signals. Like the 121040-1 deluxe output module, it has the capability to modify the characteristics of the eight AES-formatted digital audio input signals that it converts.

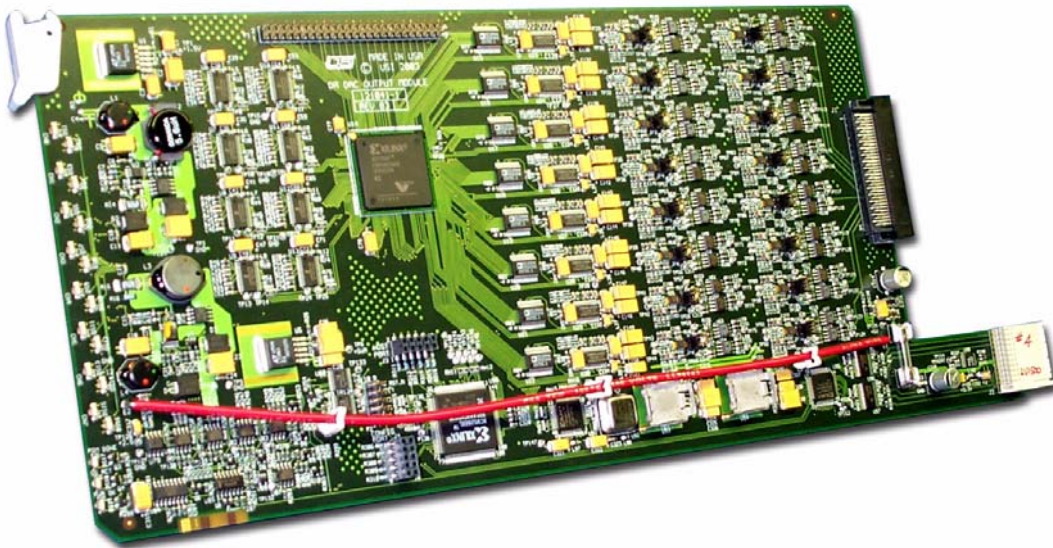

FIGURE 4-31. DAC Output Module

These capabilities include the following:

- Execution of a V-fade that ensures clickless synchronous switching of output.
- Execution of analog channel data manipulations within each AES signal pair:
- Automatic adjustment to input word lengths of 16 to 24 bits.
- Addition of dither to output signals at user discretion.

These capabilities are accessed by control and status monitoring via embedded JTAG control structures included in the Utah-400 router platform.

Further, these operations are performed in concert with the channel status (C-bit) indications at the AES inputs, with outputs set appropriately, according to parameters from inputs and commanded functions.

This module also includes the provisions present on the standard output module (USI 121027-1), i.e. AES signal presence detection, protection input switching capability, and monitor matrix functionality. In addition, payload audio signal presence detection is provided at a threshold of -48 dBfs for both embedded channels for signal integrity monitoring.

The module's digital monitor matrix output is derived from digital domain signal processing data at a point just before application to the channel's sample-rate and digital-to-analog converters. C-bits at the monitor matrix output are transmitted according to the indications at the selected input, with modifications consistent with commanded signal processing functions.

In order to properly perform its intended function, the V-fade facility is expected to operate with signal sources that are synchronous to the router's DARS (digital audio reference signal). If either (or both) the pre- or post-switch sources are asynchronous, the hardware will still execute the commanded V-fade operation, but at the switching point, it will have to acquire the frequency and phase of the new signal, extending the muting interval while it does so.

Signal processing on each AES channel includes a sample rate converter (SRC) just before that channel's digital-to-analog converter (DAC). This is done to capitalize on the jitter attenuation capability of the SRC, maximizing the resultant signal-to-noise ratio and minimizing the distortion of converted signals, independent of their specific sample rates. The DACs are always operated at 48 kHz sample-rate, as derived from a local master clock and the SRCs.

To support multi-channel operation, the SRCs can be operated with matched group delay. (The default condition, when the SRCs are operated independently, is an uncertainty of up to several milliseconds.) This is accomplished by identifying all AES signals that are part of the multi-channel (matched-phase) group. These signals must be synchronous with one another and connected to a single DAC output module. A control bit is set to identify each AES signal pair that is to be part of the group. Within the designated group, one AES signal is indicated as "phase master". The phase master conveys sample-rate conversion data to all other AES channels in the group, i.e. the slaves, locking their conversion processes together for proper multi-channel performance with uniform group delay. The phase master is designated with a control word applied through the embedded JTAG control structure.

This module is substituted for the standard output module in a Utah-400 chassis, on an as-needed basis; to bring the above enhanced features and analog functionality to those specific system outputs. Since it derives two-channel analog outputs from each AES input signal, this module requires a special output adaptor fitted with two balanced audio connectors.

ADC Input Module

This Input module, USI 121042-1, is an alternate input module for the Utah-400 digital audio router with capability to accept eight two-channel analog input pairs, formatting them into eight AES digital audio signals for application to the routing matrix. This module is substituted for standard input modules on an as-needed basis (as constrained by options for deployment of analog I/O adaptor subassemblies and power).

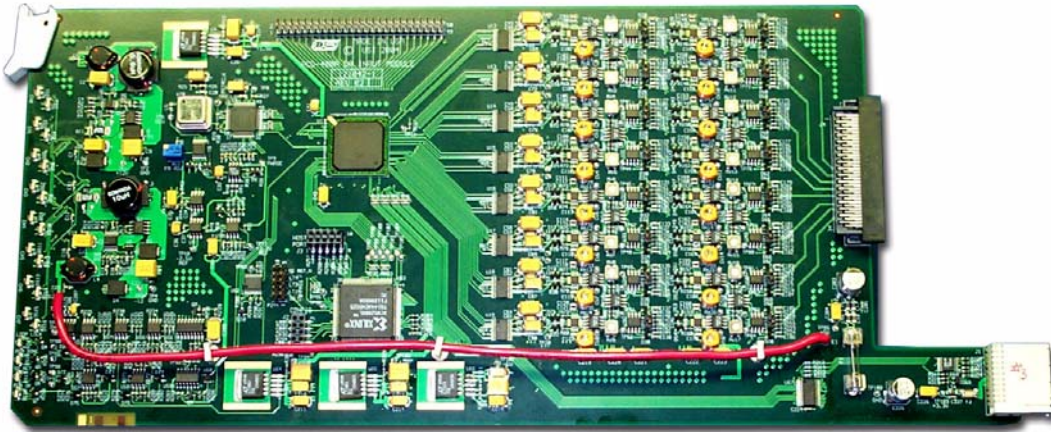

FIGURE 4-32. ADC Input Module

The following feature set is embodied in this module:

- Audio sample word-length adjustable to 16, 18, 20, or 24 bits, by AES channel-pair, at user discretion.
- Automatic non-subtractive dither, with triangular PDF, applied to signals configured at reduced word-lengths.
- Analog input signal presence detection at -48 dBfs (28 to 30 dB below operating level) with 5-second moving detection window, provision to detect individual channel signal activity
- Selectable input muting, for each individual analog input channel.
- High-impedance bridging inputs with strap-selectable 600 Ω termination.
- Configurable “encoded channel mode” (including multi-channel modes) for C-bit indications in the AES-formatted output signals.
- Error indications for signal overload (clipping), for each individual analog input channel.

Deluxe Output Board

- Converted signals are synchronous to the system DARS. If the DARS is unavailable or invalid, a fallback crystal oscillator provides an asynchronous master clock rendering a 48 kHz sample rate. This module also includes the standard (for Utah-400) feature of auxiliary LVDS outputs for expansion and protection applications. Control and status reporting is accomplished via a ScanGate Type-4 chip communicating over the system's JTAG bus. Some of the module's extended features are accessed via virtual TAPs contained in its signal-processing hardware and connected to local TAPs of the ScanGate Type-4 device.

Audio Crosspoint Board (Single Chassis version)

Part number 121030-1, the Audio Crosspoint card contains the same option for two imbedded controllers as its video counterpart.

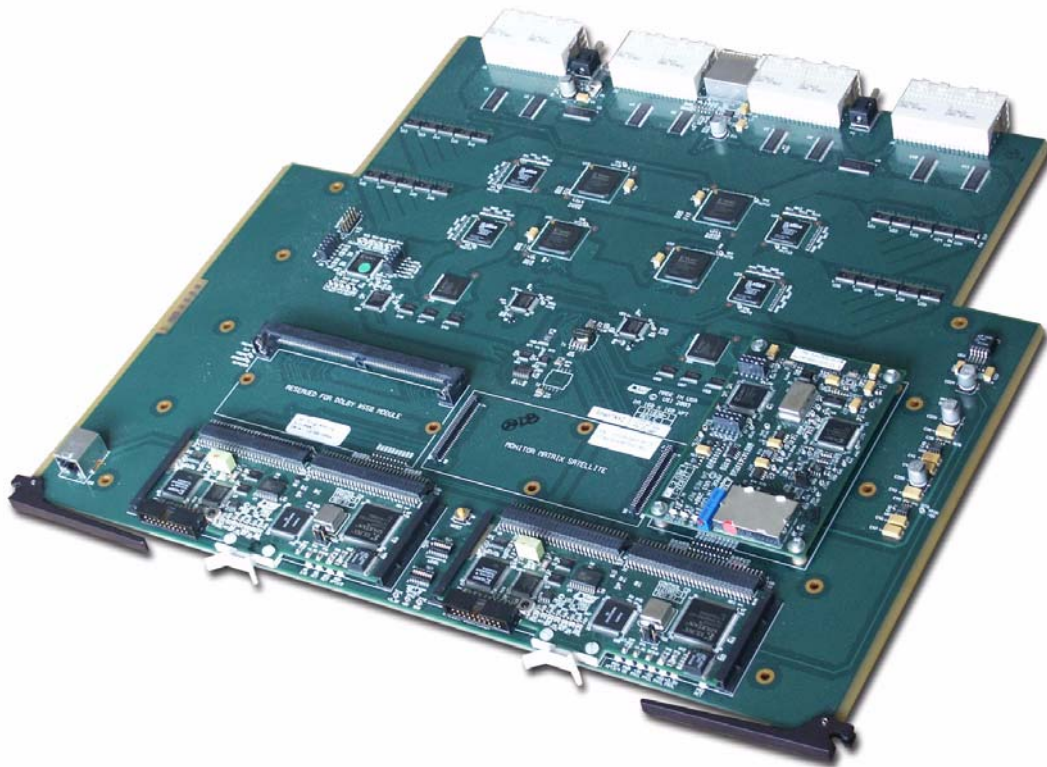
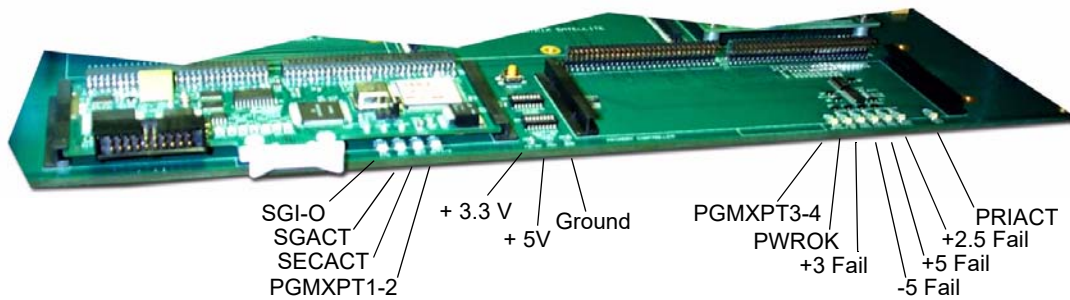

FIGURE 4-33. Audio Crosspoint board

Front Edge Card Indicators (Left Bank)



SGI-O (Scangage I/O)

This indicator will be active when the commanding processor communicates out the bus to the I/O cards.

SGACT (Scangate Active)

A general indicator for processor communication. This may indicate communication between the input/output boards, or the submodule on the crosspoint card itself.

SECACT

Illuminated when the redundant FPGA is active.

PGMXPT1-2

Indicates valid programming – Green LED.

Front Edge Card Indicators (Right Bank)

PGMXPT3-4

Indicates proper programming – Green LED.

PWROK

A status check for the various power supplies on the crosspoint card. Indicates Green for normal.

Power Supply Fault Indications

+3 Fail -- + 3.3 voltage D.C. Failure

-5 Fail – -5 voltage D.C. Failure

+5 Fail-- +5 voltage D.C. Failure

+2.5V Fail – - + 2.5 voltage D.C. Failure

PRIACT (primary active)

Illuminated when the right-hand (or primary) FPGA control is active.

Audio Crosspoint Adjustments

Dip Switches

The forward dip switch indicates input and output offsets, which is identical to the video implementation.

The rear dip switch is used for level setting, which is adjusted to set the operating level, or the 'programming' level of the particular matrix.

Crosspoint Reset Button

Resets the board logic – normally this is not used by the user.

This may be utilized in circumstances where power supplies are changed or other anomalies occur.

Caution: Pressing the reset button would erase any switched up jumpers or outputs that are active.

Debug Port

Used for development and manufacturing test – not typically used by the customer. This provides a means via serial port to tie in with a computer terminal to communicate with the controllers.

Time Base Module

Part number 121032-1, this is the master clock generator for the synchronous digital audio element. This module derives an input from the midplane I/O, performs a synchronization, then generates a master clock scheme that is used both on the crosspoint board and all input modules.

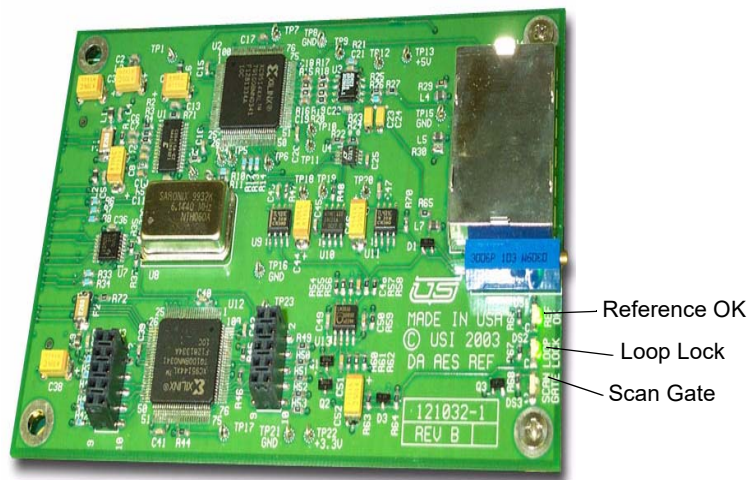

FIGURE 4-34. Audio Time Base Module

LED Indication

Scan Gate

This corresponds to the internal communication bus. This indicator will flash when an internal communication element is being received.

Loop Lock

Related to the phase lock loop clock system that is implemented on this board. This indicator will appear when the module synchronizes to the reference that is presented.

Ref OK

When lit, this indicates that a suitable reference is applied to the chassis, and the module has synchronized correctly. This then sends a signal to the input cards indicating synchronization, and that they should accept the reference that is being fed to them as the master clock.

Note: There is a fall back mode in the router if the reference is lost. The system reverts from synchronous operation to asynchronous operation. The router must remain active and continues to pass signals.

Fuses

The crosspoint modules are protected by self-resetting poly fuses (polymer based fuses). The circuit is opened when current overload occurs, then closes once cooling takes place. The board also contains one cartridge-type fuse, which supplies +3.34 to the crosspoint module itself.

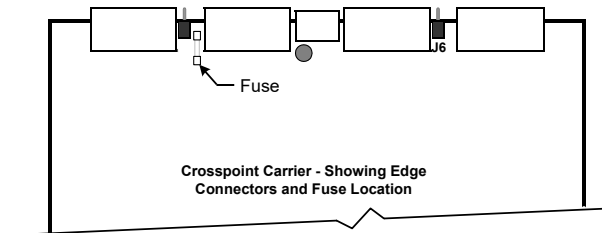
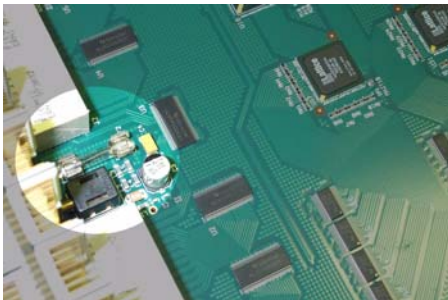

FIGURE 4-35. Crosspoint board fuse assembly

Test points (front of Crosspoint card)

In rare cases, engineering personnel may (when receiving certain voltage alarms) clip onto these points with a volt meter & make certain deductions regarding system voltages.

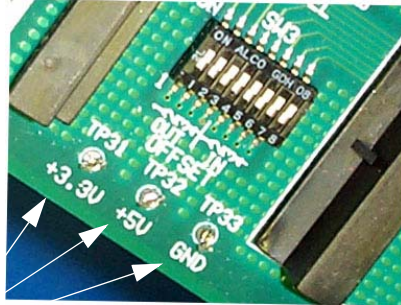

FIGURE 4-36. Audio Crosspoint board test points

Contacts

Ground

+3.3

+5

Crosspoint Card (Redundant 144 Audio Systems)

Part number 121120-1, this crosspoint card contains the same on-board indicators as described above.

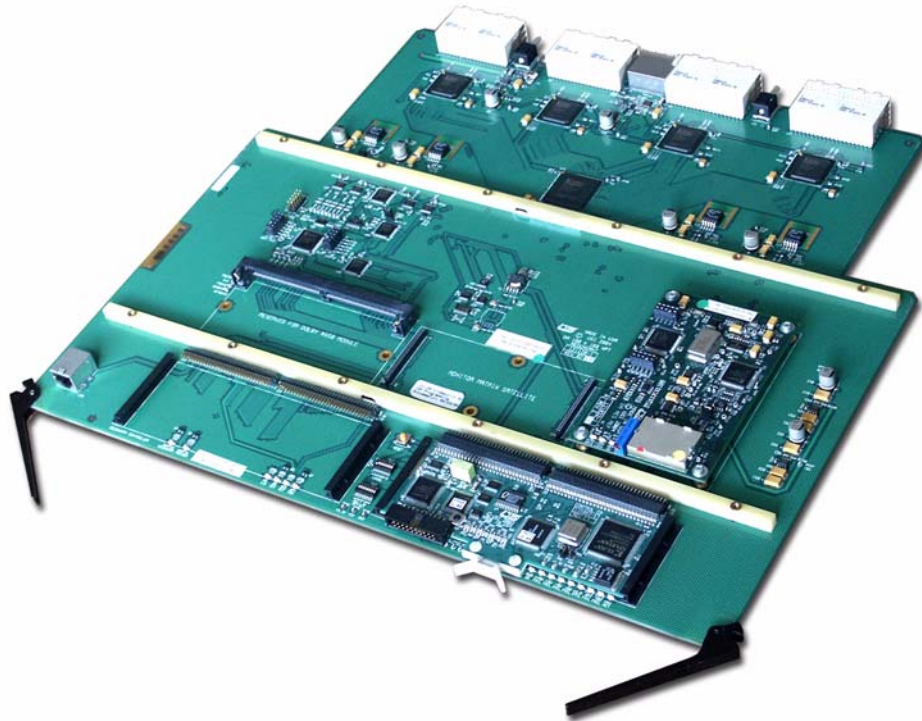

FIGURE 4-37.

Note the additional LED status detail in the table below.

LED Status - 121120 Board

TABLE 4-1.

| Sec. Config. | Primary Config. | Scangate I/O | Scangate Active | Sec. Active | X-point Program. | Power OK | Primary Active | [?] Status |
|--------------|-----------------|--------------|-----------------|-------------|------------------|----------|----------------|---------------|
| OFF | ON | ON | FLASH | OFF | ON | ON | ON | Top Active |
| ON | OFF | OFF | ON | OFF | ON | ON | OFF | Bottom Active |
| OFF | ON | OFF | ON | OFF | ON | ON | OFF | Top Active |
| ON | OFF | ON | FLASH | OFF | ON | ON | ON | Bottom Active |

White = Top Board

Green = Bottom Board

Note: Parts of this section were derived from the Utah-200 Manual; some areas may not apply directly to the Utah-400 but will be corrected in the next version of this manual.

In This Chapter

This chapter is designed to help the user diagnose problems on the Utah-400 Routers to the subsystem level. There are no repairable boards in the Utah-400 system, contact Utah Scientific Technical Services at 800-447-7204 regarding any problems you may be having. Should any printed circuit boards need repair, Technical Services can advise you on shipping and on the repair process.

| | |
|---|-----|
| Subsystem Level Troubleshooting | 5-2 |
| Main Troubleshooting Chart | 5-2 |
| Video Subsystem Troubleshooting Table | 5-4 |
| Audio Subsystem Troubleshooting Table | 5-5 |
| Power Subsystem Troubleshooting Table | 5-6 |
| Power Supply Alarms | 5-6 |
| Control Subsystem Troubleshooting Table | 5-7 |
| System Controller Alarms | 5-8 |
| Control Panel Troubleshooting | 5-9 |
| UNET Panels | 5-9 |
| Ethernet Panels | 5-9 |

Subsystem Level Troubleshooting

A routing system is typically comprised of several subsystems:

- Video System
- Audio System
- Control System
- Power System

Fault finding is simplified by first isolating the problem to one of these subsystems. For example, if the audio-system is functioning normally, but there are problems with video, the problem is probably confined to the video system.

Note: *With the exception of a system using Digital Video with embedded audio, audio signals are switched through a different matrix than the video signals.*

Main Troubleshooting Chart

The following table provides an indication of what subsystems should be reviewed for common problems.

Please note:

- The numbers shown in the four Subsystem Table Reference columns indicate specific troubleshooting problems that are found in the four individual Subsystem Tables.
- For example: a 1 listed under the Video column refers to problem number 1 in the "Video Subsystem Table" on the following page. Here you will find a list of specific checks that will assist in troubleshooting the problem.

TABLE 2-1. Main Troubleshooting Table

| Problem | Subsystem Table Reference | | | |
|---|---------------------------|-------|-------|---------|
| | Video | Audio | Power | Control |
| No Video or Audio outputs | 1 | 1 | 1,2 | 1 |
| Video and Audio outputs are present but neither can be switched | 2,3 | 2,3 | | 1,2,6 |
| No Video output, Audio functions normally | 1,2,3 | | 1 | 2 |
| No Audio output, Video functions normally | | 1,2,3 | 2 | 2 |
| Video switches normally but audio does not switch | | 2,3 | | 2 |
| Audio switches normally but the video does not switch | 2,3 | | | 2 |
| Flash on video when switching | 4 | | | |
| Cannot access expansion inputs or outputs of video level | 5 | | | |
| Audio signal level incorrect | | 4 | | |
| Video signal level incorrect | 7 | | | |
| Video signal anomaly | 5,6,8 | | | |
| Video monitor matrix not functional | 9 | | | |
| Audio monitor matrix not functional | | 5 | | |
| Control panel does not function | | | | 1,2,3 |
| Control via serial port not functional | | | | 4 |
| Ethernet control port not functional | | | | 5 |
| Alarm port active | | | 3 | 6 |
| SC-3/4 Ports not "Active" | | | 3,4 | 4,5 |
| Undefined level types in SC-3/4 Controller | | | | 1,2,4 |

Video Subsystem Troubleshooting Table

Use the following table to troubleshoot specific video subsystem problems. The numbers in the left-hand column indicate specific references from the Video column in the **Main Troubleshooting Table**.

TABLE 2-2. Video Subsystem Troubleshooting Table

| Problem | Check |
|---------|--|
| 1 | No video output <ul style="list-style-type: none"> • Control cable connected, or internal controller functional? • Different input works on output bus? • Other outputs functional? |
| 2 | Unable to select a specific input <ul style="list-style-type: none"> • Control panel programming correct? • Output signal level locked or protected? |
| 3 | Unable to select any input <ul style="list-style-type: none"> • Control cable connected? • Control panel defective? • Controller failure? |
| 4 | Video flash when switching between inputs <ul style="list-style-type: none"> • Input sources timed correctly? • Input reference signal present and timed? • Input reference correct standard? • Correct video standard jumper set on controller board? |
| 5 | Inputs / Outputs inaccessible <ul style="list-style-type: none"> • Expansion matrix crosspoint cards present? |
| 6 | Sync missing on video output (analog) <ul style="list-style-type: none"> • Sync present on selected input? • Normal DC level on input? |
| 7 | Video output level incorrect <ul style="list-style-type: none"> • Input level correct • Output terminated at destination (analog)? • Input/output compensation jumpers correctly set? |
| 8 | Sparkles on video output (digital) <ul style="list-style-type: none"> • Input signal amplitude too low? • Cable length > 300 meters on input? |
| 9 | Monitor Matrix not functional <ul style="list-style-type: none"> • Selected correctly on control panel? |

Audio Subsystem Troubleshooting Table

Use the following table to troubleshoot specific audio subsystem problems. The numbers in the left-hand column indicate specific references from the Audio column in the Main Troubleshooting Table.

TABLE 2-3. Audio Subsystem Troubleshooting Table

| Problem | Check |
|---------|--|
| 1 | No audio output <ul style="list-style-type: none">• Control cable connected, or internal controller functional?• Different input works on output bus?• Other outputs functional? |
| 2 | Unable to select a specific input <ul style="list-style-type: none">• Control panel programming correct?• Output signal level locked or protected? |
| 3 | Unable to select any input <ul style="list-style-type: none">• Control cable connected?• Control panel defective?• Controller failure? |
| 4 | Output level incorrect (analog) <ul style="list-style-type: none">• Input level correct?• Input termination in correct position?• Output termination in correct position? |
| 5 | Monitor Matrix not functional <ul style="list-style-type: none">• Selected correctly on control panel? |

Power Subsystem Troubleshooting Table

Use the following table to troubleshoot specific power subsystem problems. The numbers in the left-hand column indicate specific references from the Power column in the **Main Troubleshooting Table**.

TABLE 2-4. Power Subsystem Troubleshooting Table

| Problem | Check |
|-----------------------|--|
| 1 No video output | <ul style="list-style-type: none"> • Power applied to video frame? • Warning indicators on the front of each power supply? • Control cable between chassis connected? |
| 2 No audio output | <ul style="list-style-type: none"> • Power applied to audio frame? • Warning indicators on the front of each power supply? • Control cable between chassis connected? |
| 3 Alarm active | <ul style="list-style-type: none"> • Voltage alarm active (LED on)? • Fan alarm active (LED on)? • Temperature alarm active (LED on)? |
| 4 Controller power | <ul style="list-style-type: none"> • Power applied to controller frame? |

Power Supply Alarms

Power supply alarms are indicated by red LEDs on the front of each power supply module. They consist of voltage, fan, and temperature alarms.

- The voltage alarm indicates that one of the supply voltages is either too high or too low.
- The fan alarm indicates that the fan has stalled.
- The temperature alarm indicates that the temperature is elevated in the power supply. This may be caused by dirt or dust blocking the airway, a defective cooling fan, or by operation in extreme temperatures.

Note: *Optional redundant power supplies may be fitted to UTAH-400 systems. In this configuration, the failure of a power supply should not affect normal system operations, but users would be unaware of the power supply failure. Thus, it is highly advisable to utilize the SMPTE alarm output provided at the rear of the chassis.*

Control Subsystem Troubleshooting Table

Use the following table to troubleshoot specific control subsystem problems. The numbers in the left-hand column indicate specific references from the Control column in the **Main Troubleshooting Table**.

TABLE 2-5. Control Subsystem Troubleshooting Table

| Problem | Check |
|---------|--|
| 1 | No control of any level <ul style="list-style-type: none"> • Internal controller operating (see below) • External controller connected • Control panels connected (see below) • MX bus terminated (see below) • U-Net terminated (see below) • Completed controller software upgrade |
| 2 | No control of individual signal level or levels <ul style="list-style-type: none"> • MX bus cable connected (see below) • MX bus correctly terminated (see below) • Is non functional signal level address set correctly (see below). • Control panel programmed correctly (see "Operations") • Output locked or protected on that level (see "Operations") |
| 3 | Control panel not functional <ul style="list-style-type: none"> • Panel address set to unique number • Completed panel software upgrade |
| 4 | Serial control port not functional <ul style="list-style-type: none"> • Communications baud rate incorrect • Serial control Protocol incorrect • Serial control cable wired correctly |
| 5 | Ethernet port not functional <ul style="list-style-type: none"> • Ethernet option fitted • Connected to PC directly by null cable • Connected to network via gateway |
| 6 | Alarm active <ul style="list-style-type: none"> • Active CPU indicator extinguished (SC-4) • Heartbeat indicator extinguished (SC-4) • MX activity light does not flash (SC-4) |

System Controller Alarms

System controller alarms are indicated by LEDs on the front of each controller card.

- The active LED should be lit on one of the controller cards. If only one controller is present (non redundant system), the active LED should be illuminated.

Please note the following additional points regarding the controller:

- The heartbeat LED (DS6) indicates that the processor is communicating with the vital parts of the system and is running the application software.
- The MX LEDs indicates communication with the crosspoint matrix. The transmit LED (DS8) will flash whenever communication is being made from the controller to the matrix. The receive LED (DS7) will flash whenever communication is being received by the controller from the matrix.
- U-Net is used for communication between the controller and the control panels. The U-Net data and U-Net transmit enable LEDs (DS9 and DS10) indicate when information is exchanged between the system controller and a control panel.
- If the active LED is on and the U-Net transmit enable LED (DS10) is off, this indicates that a controller software upgrade has failed and the controller is waiting for a valid controller software upgrade to be uploaded.
- If used with an SC-4 or SC-400 system controller consult the appropriate controller manual for details about the controller card.
- The total MX bus cable length must be less than 300 feet and must be terminated at the last chassis.

Control Panel Troubleshooting

If your control panel does not control any of the matrix, check that power is applied to the panel.

UNET Panels

- Panels communicate to the controller by a special network known as U-Net. Panels are connected together daisy chain style to the controller. Removing a panel physically from the network will break the chain and disconnect panels downstream from the controller.
- U-Net uses unshielded twisted pair cable. It requires two twisted pairs terminated in an RJ 45 connector. The maximum length of any segment is 1000 feet and must be terminated at the last control panel in each segment. Refer to the Appendix C "U-Net Cabling" for details.
- The panel may be communicating to the controller correctly, but the required signal level matrix may not be responding. Check the Dipswitch setting on the rear panel of the non-functional router level.

Confirm that the control panel address is a unique number. Each panel address is set by a rear panel Dipswitch and must be a unique address. This control panel address is read when the control panel is powered up.

Ethernet Panels

- Panels should be connected to the same network as the SC-3/4 controller.
- There should be a network hub between a panel and the SC-3/4 controller.
- Unique IP addresses.
- CAT-5 cable lengths should be less than 100 meters.

Specifications

In this Appendix

This appendix provides detailed lists of all system audio, video, control, physical, power and regulatory specifications.

| | |
|--|-----|
| Power | A-2 |
| Input Power and DC Power Specifications | A-2 |
| Digital Video | A-3 |
| Digital Audio | A-4 |
| High Definition SDI Video | A-5 |
| Reference | A-5 |
| Control | A-6 |
| Alarms | A-7 |
| Physical | A-8 |
| Regulatory | A-8 |
| Connector Suppliers and USI Part Numbers | A-9 |

Power

The following table lists power specifications:

Input Power and DC Power Specifications

TABLE A-1.

TABLE 2.

| Parameter | Specification |
|---------------------------|---|
| AC Supply | |
| Input Power Consumption | 300 Watts |
| Voltage | 90 – 240 Volts AC, universal power supply |
| Frequency | 50 – 60 Hertz |
| Redundancy | Dual Redundant power supplies (optional) |
| DC Output Voltages | |
| + 12 Volts DC (VA) | 1 Amp |
| + 12 Volts DC (VB) | 1 Amps |
| + 3 Volts DC | 35 Amps |
| + 5 Volts DC | 35 Amps |

Digital Video

The following table lists the system digital video specifications.

TABLE A-1. Digital Video Specifications

TABLE 2.

| Parameter | Specification |
|-------------------------------------|--|
| Jitter and all other specifications | Conforms to SMPTE 259M; 292M |
| Data Rates | 143, 177, 270, 360 and 540 Mb/Sec With SD Re-clocking |
| Input Return Loss | >15 dB, 6 MHz. – 360 MHz |
| Output Return Loss | >15 dB, 6 MHz. – 360 MHz |
| Input Equalization up to 360 Mbps | 1000 ft. for 8281 cable |
| Signal Level | 800 mV \pm 10% |

Digital Audio

The following table lists system digital audio specifications

TABLE A-1. Digital Audio Specifications

TABLE 2.

| Parameter | Specification |
|--|--|
| Digital Audio Processing | 48 kHz. 16 - 24 Bit, AES / EBU; AES-3 |
| Input Impedance - Balanced | 110 ³ / ₄ ±20%. 100 KHz. to 6.144 MHz |
| Input Level minimum: | 200 mVPP. w/> 50% Eye Pattern Opening |
| Modes of Operation | Synchronous and Asynchronous |
| Input Level maximum: | 7 VPP |
| Common Mode Range: | ± 7V (DC + Peak Signal) |
| Common Mode Rejection: | Per AES-3, Section 6.3.5 (1997) |
| Output Impedance - Balanced | 110 ³ / ₄ ±20%, 100 kHz. to 6.144 MHz |
| Output Amplitude: | 2.0 VPP into 110?, minimum |
| Nominal Rise / Fall Times: | 25 nano seconds |
| Common Mode Rejection: | >30 dB, DC to 6 MHz |
| Sample Rate: | 48 kHz |
| Intrinsic Jitter: | < 0.025 UI Peak, w/700 Hz. HPF Applies to discrete AES outputs |
| Output Phasing with respect to DARS Input: | ± 2.5% (± 9°) of Frame Interval. Applies to discrete AES outputs |

High Definition SDI Video

The following table lists the high definition specifications:

TABLE A-1. High Definition SDI Video Specifications

TABLE 2.

| Parameter | Specification |
|-------------------------------|--------------------------------------|
| Video Standard | 10 Bit SDV, Conforms to SMPTE 292M |
| Data Rate: | 1.4835 Gbps / 1.485 Gb/Sec |
| Input Return Loss: | >15 dB; 5 MHz. – 1.485 Gb/Sec* |
| Output Return Loss: | >15 dB, 5 MHz. – 1.485 Gb/Sec* |
| Automatic input equalization: | >150 Meters with 1694A coaxial cable |
| Output Re-Clocking: | Jitter, < 0.2 UIpp (average) |

Reference

The table below lists reference specifications

TABLE A-1. Reference Specifications

TABLE 2.

| Parameter | Specification |
|-----------|-------------------------------|
| Audio | One 75Ohm terminated AES sync |

* >10db for cards operating at 1.5Gb to 3Gb/Sec

Specifications

Control

The following table lists control specifications:

TABLE A-1. Control Specifications

TABLE 2.

| Parameter | Specification |
|-------------|---------------------------------|
| Control | MX-Bus Daisy Chain - Terminated |
| Audio | One AES Audio Sync |
| SMPTE Alarm | (see below) |

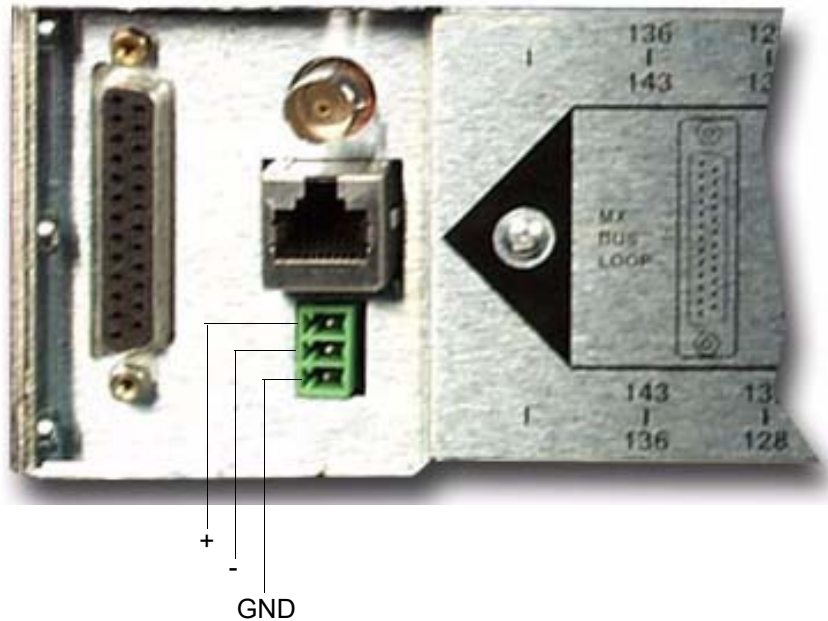

The (+) and (-) connections (above) represent two legs of a dry contact closure whenever an alarm condition exists. (Limited to a 20 milliamp current carrying capacity.)

Alarms

Alarms

The following table lists alarm specifications:

TABLE A-1. Alarm Specifications

TABLE 2.

| Parameter | Specification |
|------------------|---|
| Primary alarm | ANSI / SMPTE 269M fault reporting(Relay closure) |
| Connector Type | Phoenix Male Barrier Strip – 3 pin |
| Functions | <ul style="list-style-type: none">• Power• Temperature• Fans• System Board Failure |
| Maximum current | 20 milli-Amp |

Specifications

Physical

The following table lists physical specifications:

TABLE A-1. Physical Specifications

TABLE 2.

| Parameter | Specification |
|-------------------|---|
| Width | EIA – RS-310 – D 92 19” rack mount standard |
| Height | 8 RU, 14 inches, 356 mm |
| Depth | 19 inches, 483 mm maximum |
| Weight | 70 pounds |
| Mounting | Eight front mount rack ears |
| System connectors | All connectors rear panel mounted |
| Cooling | Four Blowers – rear exhaust |
| Temperature range | 10 – 40 Degrees Celsius |
| Humidity range | 0 – 90% non - condensing |

Regulatory

The following table lists system regulatory specifications

TABLE A-1. Regulatory Specifications

TABLE 2.

| Parameter | Specification |
|-------------------|--|
| EMC | EN50 081-1 (EN50 022 Class A) |
| Susceptibility | EN50 082 (IEC 801-3, IEC 801-4) |
| Safety | EN60 950, UL 1950, CSA 022.2 No. 234 |
| Shock / Vibration | MIL Std. 810E, Method 514.4(cargo truck 500 / 500 miles) |

Connector Suppliers and USI Part Numbers

The following table lists connector supplies and Utah Scientific Part Numbers where applicable: Not all connectors are used on the Utah-400 but are supplied as a courtesy.

TABLE A-1. Connector Suppliers

TABLE 2.

| Manufacturer Part Description | Part Number | USI Part No. | Contact |
|---|-------------------------------|--------------------------|--|
| Advanced Connectek USA Inc. | | | 714 – 573-1920 |
| <ul style="list-style-type: none"> DB-26B – Male connector, crimp | DH-26PK-SFG-T | 41226-2026 | |
| Conec Corp. | | | Ontario, Canada 905 – 790-2200 American Conec Corp. 102 Pleasant Wood Ct. Morrisville, NC 27560 (919) 460-8800 |
| <ul style="list-style-type: none"> DB-26B – Male connector, solder cup | CDS26LFHD SN163A1660 9X | 41226-3026 | |
| Amp | | | AMP Inc. Harrisburg, PA 17105 (800) 522 – 6752 |
| <ul style="list-style-type: none"> BNC Male connector | 225395-2 5-569278-2 | 41215-0001 41211-0011 | |
| <ul style="list-style-type: none"> RJ-45 Male connector | 747904-2 | 41223-1009 | |
| <ul style="list-style-type: none"> DB-9B Male connector | | | |
| Phyco | | | Kimball Electronics 1600 Royal St.; GO-149 Jasper, IN 47549 (800) 634-9497 |
| <ul style="list-style-type: none"> 6 pin CirDin | A-9001-069 | 41329-1006 | |

Specifications

The Debug Port

This Appendix contains the following:

| | |
|--|------|
| Utah-400 Firmware | B-2 |
| Version 2.09 Release Notes | B-2 |
| Version 2.08 Release Notes | B-2 |
| Menu Items | B-2 |
| Status | B-3 |
| The Debug Cable | B-3 |
| Using the Debug Port | B-4 |
| Startup Display | B-5 |
| Main Menu Display | B-5 |
| FPGA Memory Status | B-6 |
| Verifying the Software Version | B-6 |
| Checking the Router Crosspoint Status | B-7 |
| Checking Input / Output Card Information | B-10 |
| IO Information – full display | B-11 |
| IO Card Information – Locator Diagram | B-12 |
| Hardware Status Display | B-13 |

Utah-400 Firmware

Version 2.09 Release Notes

2.09 is an enhancement to the 2.08 version. Some disturbances, specifically from Panasinic MII machines, were of such short duration that the polling method of determining that a source had unlocked and then re-locked was not adequate. A 'change since last read' register in the TVP5145 was utilized to determine when this had happened and reset the input channel, if so configured. All menu items are the same as 2.08.

Version 2.08 Release Notes

The difference between FW version 2.08 and 2.07 solely deals with the 121045-1 Analog to Digital Conversion cards.

A function and associated menu items was added that allows a selectable reset of the converter chips on these cards when the transition from an unlocked state to a locked state. This was put in place due to an issue with the ADC chips that prevented them from successfully locking to a source after having been fed non-standard video for a period of time. This typically manifests itself on inputs fed by satellite or microwave receivers that transition from a de-tuned mode (where unwanted video is put out) to a tuned mode where real video is generated.

Menu Items

To enable this feature on a given block of 8 inputs, a series of commands must be entered.

1. "CNTRL + D" (Hold down the CONTROL key and press D). This enables the debug mode.
2. Use upper case U and D keys to direct the software to the card you wish to enable this function on. After each entry, the card that the software is 'pointed' to is reported.
3. The number 6 is then entered to enable or disable the function on this card.
 - a. When the '6' key is pressed, the system will report a string of bits that represent whether or not the function is enabled for each card slot. This data takes the form of 40 bits, represented in 5 bytes of hex data. A 1 in a bit position indicates that the function is enabled for that card.

Status

Whenever this auto-reset function is performed by the software, a report is issued to the debug port of the router. It takes the form of an "*" followed by two numbers -- the hexadecimal address of the card, and the number, 0 0 7, of the input that was reset.

The Debug Cable

The Debug Cable is a full duplex serial cable, consisting of an RJ-45 Connector on one end and DB-9S (female) connector at the other end. Refer to the figure below if you wish to build your own cable for the debug port.

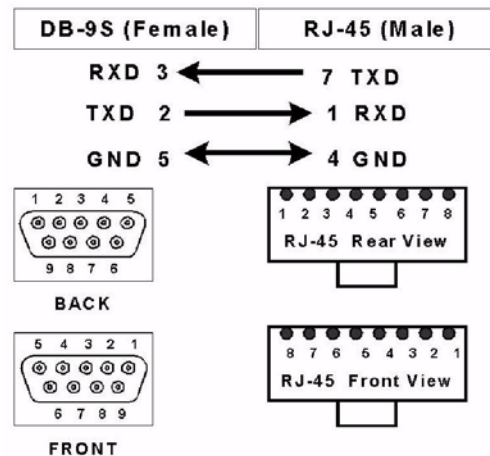

FIGURE B-1. Debug Port Cable Pinouts

The terminal settings for the debug port are: **Baud Rate = 38.4 K baud; 8 Data Bits; 1 Stop Bit; No Parity; ASCII Translation and CR = CRLF** (carriage return, line feed).

The Hyper-Terminal will have the same settings as above; but since the Hyper –Terminal does not have a CRLF setting a similar parameter is set by doing the following:

- Click on "Open Port" and set the Baud Rate, Parity, and Stop Bits.
- Select "None" in the Flow Control Box", Click "OK".

- On the Hyper-Terminal window select “File”, click on “Properties”.
- Click the “Settings Tab” in the Properties Window.
- Click the “**ASCII Setup**” Button.
- In the “ASCII Receiving Block” at the bottom of the window, **checkmark** (enable) the “**Append Line Feed to Incoming Line Ends**” and “**Wrap Lines that Exceed Terminal Width**”. These parameters perform the same function as the Terminal’s CRLF Setting.

Using the Debug Port

The debug port is the RJ-45 female connector labeled J1, located on the left hand side of the crosspoint. Its capabilities include:

CAUTION: Because this connection is located back from the board edge, the locking mechanism on a standard RJ-45 connector will be difficult to disengage. It is recommended that the locking tab be removed from the RJ-45 connector before connecting it to J1.

- System **Power Up** Display
- **Main Menu** Display.
- Verifying the **FPGA Memory Status**.
- Verifying the **Software Version**.
- Checking the **Router Crosspoint Status** to verify switching.
- Checking the **I / O Card Information**.
- Checking the **Hardware Status**.

Only the “Active” FPGA Control board will be read by the Debug Port. By pressing the “Reset” button on the currently active FPGA board, the control should be transferred to the inactive board.

If both FPGA’s are to be checked, be sure to press the “Reset” button after reading the first board.

Caution: Resetting the control card will cause a brief interruption of all Audio/ Video paths in the system.

Startup Display

If the router debug and terminal is connected to the Utah-400 system during the power up sequence, the following display will appear on the terminal.

```
*****  
      lash Set...  
      00 00 00 00 FF  
      XPT Enabled  
*****
```

This display contains ADC setup information and is generally for factory use only.

Main Menu Display

The main menu displays the selections possible on the router debug port.

After connecting the router debug port to the crosspoint board, activate the Main Menu by pressing <Enter> or <Return> on the terminal or computer. The display will be as shown below and is self explanatory:

```
Menu-  
M = FPGA Memory Status  
V = Version  
R = Router Crosspoint Status  
I = IO Card Information  
S = Hardware Status
```

FPGA Memory Status

Typing an upper or lower case “M” on the keyboard activates this feature. This display function enables the user to examine the crosspoint status as reported by the FPGA Controller. The status display and explanation is shown below.

| | |
|------------------------------|--------------------------|
| FPGA MEMORY STATUS | Min / Max Values |
| Level Switch = 00 | Range = 00 to 1F |
| Offset Switch = 00 | Range = 00 to FF |
| MX Active? -> YES. | Yes / No |
| Monitor Matrix = FF | Range = 00 to 1F |
| Primary / ID Reg = 01 | 01 or 61 only |
| FPGA Rev = X.XX | Reflects Current Version |

| Parameter | Description |
|----------------|---|
| Level Switch | Reflects the Router Level that is selected when the dipswitch is turned “Off” (toward the silkscreen number) on the crosspoint board. |
| Offset Switch | Reflects any router offsets selected. |
| MX Active | Indicates the MX Bus is active. If there is a “No” showing in this block, the MX Cable may be disconnected or the MX Bus daisy chain may not be terminated. |
| Monitor Matrix | Reflects the Monitor Output currently switched up. FFh = Default, Mon. Mtx. not switched up. |
| FPGA Revision | Subject to change. |

Verifying the Software Version

This feature is the same as the Start Up Display with the exception of the “Set to Primary” message. Typing an upper or lower case “S” on the keyboard activates this feature. The displayed data is shown below.

```
*****  
Utah Scientific Inc.  
Utah-400 System Monitor, Rev. X.X  
*****
```

Checking the Router Crosspoint Status

To activate this feature press an upper or lower case “R” on the keyboard. This feature displays all of the crosspoints and indicates which crosspoints are switched up. The table displayed is arranged in blocks of 16.

When the router is initially powered up the display will be all FF’s. This screen displays the Inputs that are switched up to the respective output in the crosspoint matrix. To check if an Input / Output has been switched up, first switch up the Input / Output and then press “R” again to refresh the screen. The display should reflect the Input / Output change to the router matrix.

Thus, if Input 00 is switched up to all outputs, after pressing “R” the crosspoint status block will show all 00’s.

An example of the screens is shown below:

Crosspoint display after router is powered up (Hexadecimal):

```
ROUTER STATUS
0+000 FF,FF,FF,FF,FF,FF,FF,FF,FF,FF,FF,FF,FF,FF,FF,
0+010 FF,FF,FF,FF,FF,FF,FF,FF,FF,FF,FF,FF,FF,FF,FF,
0+020 FF,FF,FF,FF,FF,FF,FF,FF,FF,FF,FF,FF,FF,FF,FF,
0+030 FF,FF,FF,FF,FF,FF,FF,FF,FF,FF,FF,FF,FF,FF,FF,
0+040 FF,FF,FF,FF,FF,FF,FF,FF,FF,FF,FF,FF,FF,FF,FF,
0+050 FF,FF,FF,FF,FF,FF,FF,FF,FF,FF,FF,FF,FF,FF,FF,
0+060 FF,FF,FF,FF,FF,FF,FF,FF,FF,FF,FF,FF,FF,FF,FF,
0+070 FF,FF,FF,FF,FF,FF,FF,FF,FF,FF,FF,FF,FF,FF,FF,
0+080 FF,FF,FF,FF,FF,FF,FF,FF,FF,FF,FF,FF,FF,FF,FF,
```

FIGURE B-2. Crosspoint display (hex)

Crosspoint display with Inputs switched to Outputs diagonally (Hexadecimal):

```
ROUTER STATUS
0+000 00,01,02,03,04,05,06,07,08,09,0A,0B,0C,0D,0E,0F,
0+010 10,11,12,13,14,15,16,17,18,19,1A,1B,1C,1D,1E,1F,
0+020 20,21,22,23,24,25,26,27,28,29,2A,2B,2C,2D,2E,2F,
0+030 30,31,32,33,34,35,36,37,38,39,3A,3B,3C,3D,3E,3F,
0+040 40,41,42,43,44,45,46,47,48,49,4A,4B,4C,4D,4E,4F,
0+050 50,51,52,53,54,55,56,57,58,59,5A,5B,5C,5D,5E,5F,
0+060 60,61,62,63,64,65,66,67,68,69,6A,6B,6C,6D,6E,6F,
0+070 70,71,72,73,74,75,76,77,78,79,7A,7B,7C,7D,7E,7F,
0+080 80,81,82,83,84,85,86,87,88,89,8A,8B,8C,8D,8E,8F,
```

FIGURE B-3. Crosspoint display - Inputs to Outputs

Crosspoint display with Input 00 switched up to all outputs (Hexadecimal):

```
ROUTER STATUS
  0+000 00,00,00,00,00,00,00,00,00,00,00,00,00,00,00,00,00
  0+010 00,00,00,00,00,00,00,00,00,00,00,00,00,00,00,00
  0+020 00,00,00,00,00,00,00,00,00,00,00,00,00,00,00,00
  0+030 00,00,00,00,00,00,00,00,00,00,00,00,00,00,00,00
  0+040 00,00,00,00,00,00,00,00,00,00,00,00,00,00,00,00
  0+050 00,00,00,00,00,00,00,00,00,00,00,00,00,00,00,00
  0+060 00,00,00,00,00,00,00,00,00,00,00,00,00,00,00,00
  0+070 00,00,00,00,00,00,00,00,00,00,00,00,00,00,00,00
  0+080 00,00,00,00,00,00,00,00,00,00,00,00,00,00,00,00
```

FIGURE B-4. Crosspoint display - input 00 switched to outputs

Crosspoint display shown as a decimal matrix:

(This is shown for reference only; the terminal display will always be in the Hexadecimal format)

```
ROUTER STATUS
  0+000 000,001,002,003,004,005,006,007,008,009,010,011,012,013,015,016,
  0+010 017,018,019,020,021,022,023,024,025,026,027,028,029,030,031,032,
  0+020 033,034,035,036,037,038,039,040,041,042,043,044,045,046,047,048,
  0+030 049,050,051,052,053,054,055,056,057,058,059,060,061,062,063,064,
  0+040 065,066,067,068,069,070,071,072,073,074,075,076,077,078,079,080,
  0+050 081,082,083,084,085,086,087,088,089,090,091,092,093,094,095,096,
  0+060 097,098,099,100,101,102,103,104,105,106,107,108,109,110,111,112,
  0+070 113,114,115,116,117,118,119,120,121,122,123,124,125,126,127,128,
  0+080 129,130,131,132,133,134,135,136,137,138,139,139,140,141,142,143,
```

FIGURE B-5. Crosspoint display as decimal matrix

Checking Input / Output Card Information

Typing the upper or lower case "I" activates this feature. This display provides up to date information on the types of Input and Output boards in the system, the revision of each board and the Monitor Matrix Output that is switched up.

The display format (per line) is shown below:

| | | | | | | | | | | | |
|----|----|-----|------|------|----|------|----|----|----|----|----|
| | ① | | ② | ③ | ④ | | ⑤ | ⑥ | ⑦ | ⑧ | ⑨ |
| Cd | XX | PN: | XXXX | - XX | XX | IO = | 00 | 00 | 00 | 00 | 00 |

- | | |
|--|--|
| <p>① Chassis location of Card: Range - 00h to 27h</p> <p>② Four Digit Part Number of Card</p> <p>③ Card Dash Number</p> <p>④ Card Revision Number</p> <p>⑤ Signal Presence Indicator</p> | <p>⑥ Card Specific Range = 00h to FFh</p> <p>⑦ Card Specific Range - 00h to FFh</p> <p>⑧ Card Specific Range - 00h to FFh</p> <p>⑨ Monitor Matrix Output Reported; (Indicated on Output boards only) 08h = Out 0, Monitor Matrix Enabled; 0Fh = Out 7 on; Default = 8Fh; Off = 00h</p> |
|--|--|

| | | | | | | | | | | |
|----|----|-----|------|--------|------|----|----|----|----|----|
| Cd | 00 | PN: | 1026 | - 10A0 | IO = | 01 | 00 | 10 | 00 | 0F |
|----|----|-----|------|--------|------|----|----|----|----|----|

Typical Data represented by a Digital Audio Input Board: Card Slot 00, Board Part Number = 1026, Dash Number = 10, Revision A, IO Data = Input 00 contains **signal present**.

| | | | | | | | | | | |
|----|----|-----|------|--------|------|----|----|----|----|----|
| Cd | 05 | PN: | 1027 | - 1001 | IO = | 01 | 04 | 00 | 00 | 00 |
|----|----|-----|------|--------|------|----|----|----|----|----|

Typical Data represented by a Digital Audio Output Board: Card Slot 05, Board Part Number = 1027, Dash Number = 10, Revision 01, IO Data = Output 00 contains **signal present**.

- ⑤ **Signal Presence Indicator:** The byte of information contains a single bit that indicates presence (1) or not (0) for each input or output on the card.

| | | | | | | | | |
|----------------|----|----|----|----|----|----|----|----|
| Input / Output | 0 | 1 | 2 | 3 | 4 | 5 | 6 | 7 |
| Value | 01 | 02 | 04 | 08 | 10 | 20 | 40 | 80 |

FIGURE B-6. Display format - I/O card info

Note: These values Add if more than 1 I/O contains a signal. (FF = All Signals Active)

IO Information – full display

The complete terminal display of IO Information is shown below. This is how this screen should appear, dependent on the size of your system. A smaller system will have a larger portion of the screen showing boards “Not Installed”. Note: on the bottom of the display, data on the system crosspoint is reflected. This data is also available in the Hardware Status feature.

```
IO CARD INFORMATION =
Cd 00 PN:0967-1003 IO = 000000000F | Cd 01 PN:2407-1003 IO =
0400000000 |
Cd 02 PN:2407-1003 IO = 0000000000 | Cd 03 PN:2407-1003 IO =
0000000000 |
Cd 04 PN:2407-1003 IO = 0000000000 | Cd 05 PN:2406-1003 IO =
FF00000000 |
Cd 06 PN:0966-1003 IO = FF00000000 | Cd 07 PN:0966-1003 IO =
FF00000000 |
Cd 08 PN:2406-1003 IO = FF00000000 | Cd 09 PN:0966-1003 IO =
FF00000000 |
Cd 0A PN:2407-1003 IO = 0000000000 | Cd 0B PN:2407-1003 IO =
0000000000 |
Cd 0C PN:2407-1003 IO = 0000000000 | Cd 0D PN:2407-1003 IO =
0000180000 |
Cd 0E PN: Not Installed | Cd 0F PN:2406-1003 IO =
FF00000000 |
Cd 10 PN:2406-1003 IO = FF00000000 | Cd 11 PN:0966-1003 IO =
FF00000000 |
Cd 12 PN:2406-1003 IO = FF00000000 | Cd 13 PN: Not Installed
|
Cd 14 PN:2407-1003 IO = 0100000000 | Cd 15 PN:2407-1003 IO =
0000000000 |
Cd 16 PN:2407-1003 IO = 0000000000 | Cd 17 PN:2407-1003 IO =
0000000000 |
Cd 18 PN:2407-1003 IO = 0000000000 | Cd 19 PN:2406-1003 IO =
FF00000000 |
Cd 1A PN:2406-1003 IO = FF00000000 | Cd 1B PN:2406-1003 IO =
FF00000000 |
Cd 1C PN:2406-1003 IO = DF00000000 | Cd 1D PN: Not Installed
|
Cd 1E PN:2407-1003 IO = 0000000000 | Cd 1F PN:2407-1003 IO =
0000000000 |
Cd 20 PN:4128-1001 IO = DF00000000 | Cd 21 PN:4128-1001 IO =
FF00000000 |
Cd 22 PN: Not Installed | Cd 23 PN:2406-1003 IO =
FF00000000 |
Cd 24 PN:2406-1003 IO = FF00000000 | Cd 25 PN:4121-1001 IO =
8000000000 |
Cd 26 PN:4121-1001 IO = F700000000 | Cd 27 PN: Not Installed
|
Crosspoint = 4120-105A
```

FIGURE B-7. I/O info - Full display

IO Card Information – Locator Diagram

The following diagram gives an illustration of how the IO Information display actually relates to the physical chassis. This is a useful tool for locating suspect Inputs or Outputs or just for changing or Input or Output boards to your system.

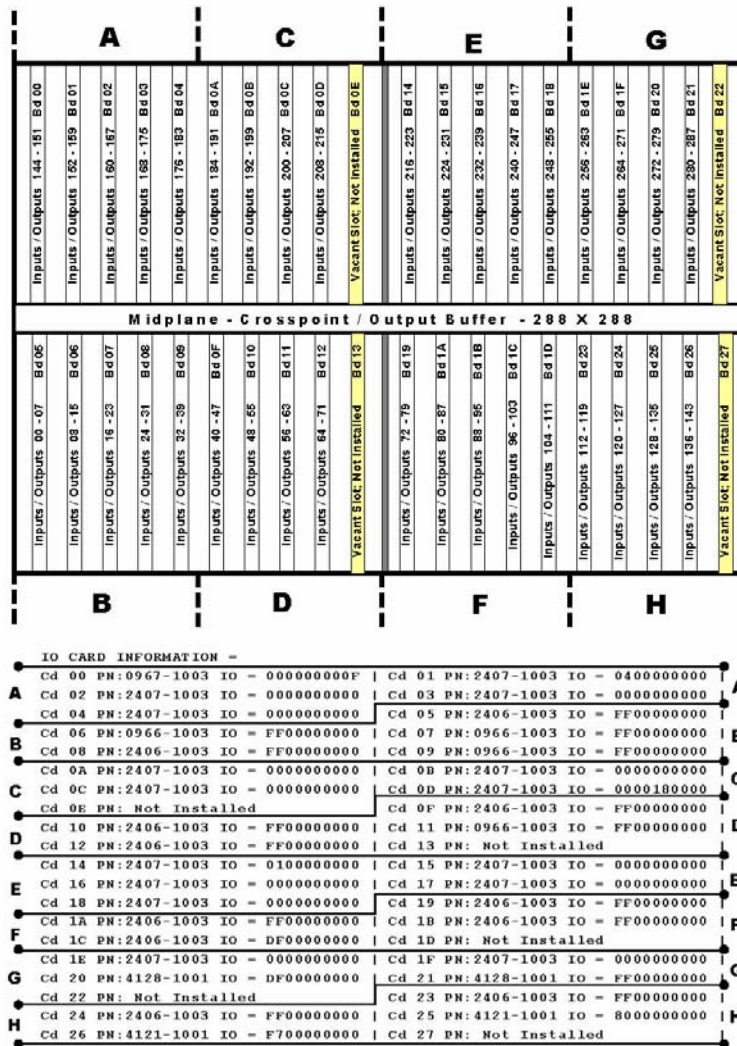

FIGURE B-8. I/O card information - locator diagram

Hardware Status Display

By pressing the lower or upper case “S” the Hardware Status is displayed on the screen. This display gives a snapshot of the current condition of the major system components being monitored in the router.

The display will be similar to what is shown below. A brief description of the data is explained below.

```
HARDWARE STATUS
Crosspoint type = HD/SD XXX x XXX (AES XXX x XXX)
Slot = Primary
Fan Status =
  Fan 1 OK. | Fan 2 OK. | Fan 3 OK. | Fan 4 OK. |
Local PS Status =
  5V OK . | 3.3V OK. | 2.5V OK.
External PS Status =
PS1 (RH) Installed -> YES. | Error Code -> No Error | TEMP -> 32C
PS2 (LH) Installed -> YES. | Error Code -> No Error | TEMP -> 32C
```

- Crosspoint type: Reflects the type of crosspoint card installed in your system and its matrix size – 144 x 144, 288 x 288 or larger.
- Slot: Refers to the FPGA Controller board currently active; primary or redundant.
- Fan Status: All system fans are detected by the FPGA, the status is reported back as “OK” or “Failed”.
- Local PS Status: Monitors all voltages on the crosspoint and reports any errors as “Failed”.

External PS Status: Reflects the status of the power supplies installed in the system and reports any errors. The temperature of each power supply is also monitored in Celsius. If a power supply is not installed, there is a “No” following the arrow.

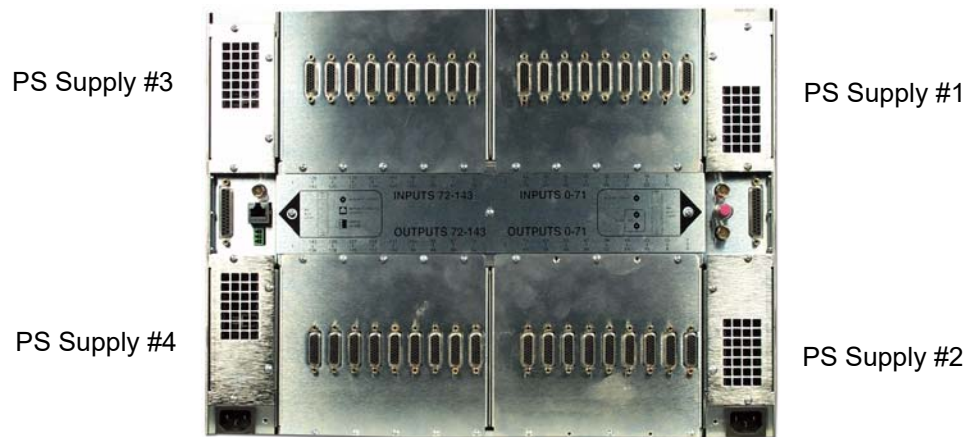

*The Utah-400 Digital Audio
Breakout Panel*

This Appendix contains the following:

| | |
|--|-----|
| Scope | C-2 |
| The AES Breakout Panel Kit | C-2 |
| Description of the AES Breakout Panel | C-2 |
| Installation of the AES Breakout Panel | C-3 |
| Label Instructions for the Utah-400 Breakout Panel ... | C-5 |
| Scope | C-5 |
| Application | C-5 |

Scope

This Appendix applies only to the installation of the AES Digital Audio Break Out Panel. The Breakout Panel and Cables are pre-tested at the factory before shipment and do not need any modifications. The customer is responsible for wiring the Sources and Destinations to each panel.

The AES Breakout Panel Kit

Each breakout panel kit ordered from Utah Scientific is shipped with the following items:

- (1) Breakout Panel - Model BDA-400, Part Number 140001-1.
- (9) 3 foot D/D 26 pin high density cables (part number 65366-3).
- (1) field wiring kit, which includes nine tension grip connectors and nine hoods.

Description of the AES Breakout Panel

The AES Breakout Panel is designed to simplify the installation of the Utah-400 Balanced Digital Audio Routing System. The 26 pin high-density connectors are pre-wired to connect directly between the Utah-400 Balanced Digital Audio backplane and the breakout panel. Only a screwdriver is needed for this installation.

The Breakout panels are generic; they may be used for either sources or destinations.

Each panel is silk screened from 0 on the left, to 71 on the right. Each labeled block on the rear of the panel corresponds to the labeled block on the front of the panel.

Installation of the AES Breakout Panel

To install the Breakout Panel:

1. Install the BOP at the desired location on the rack frame. (Within three feet of the Utah-400 Digital Audio Backplane.)
2. Install the D/D 26 pin cables from the Utah-400 input or output 00 - 07 to the BOP backplane input or output 00 - 07. Continue in the same manner for each input or output for the remaining eight blocks on the breakout panel.
3. Unpack the Field Wiring Kit and connect the required sources or destinations to each of the tension clamp connectors. Refer to Figure D-2, on the following page for wiring each tension clamp connector.

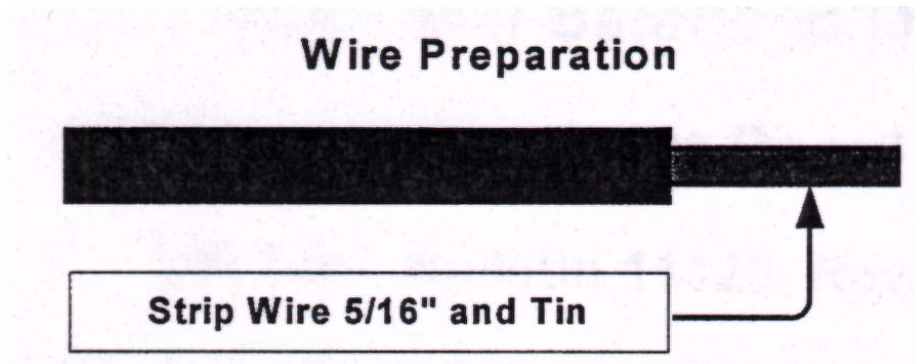

FIGURE C-1. Wire Prep

1. Insert the small screwdriver into the rectangular holes to release the wire clamp.
2. Insert the wire into the round hold above or below the rectangular slot.
3. While holding the wire in the hole, pull out the screwdriver (inserted in Step 1).
4. Tug on the inserted wire to verify that it is properly clamped.
5. Repeat for the entire connector.

*Note: Wiring is the same for each sequential block following 0 - 7. Example; 8 - 15, 16 - 23, etc. **Failure to follow these steps will result in loose or no connections, and the wire may fall out of the hole.***

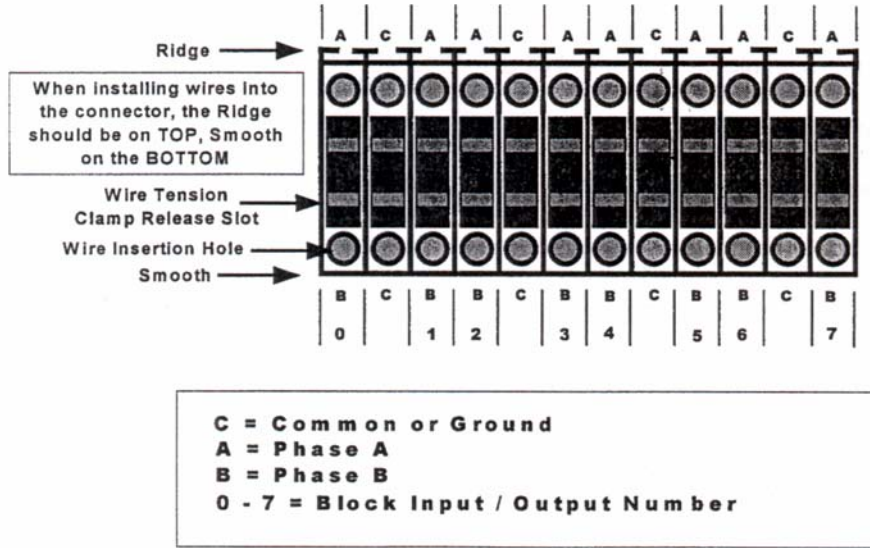

FIGURE C-2. Tension Clamp Connector (viewed from the back)

Label Instructions for the Utah-400 Breakout Panel

Scope

This document applies to the label installation on the Utah-400 Breakout Panel. Labels included in this kit include the 54450-1035 (Input Labels 000 through 287) and 54450-1036 (Output Labels 000 through 287).

Section Two of this document shows the proper wiring techniques to use on the Breakout Panel.

Application

The labels provided for the Utah-400 Breakout Panels are to be applied over the silk-screened blocks (00 – 71) below the front and back connectors on each panel. Each label sheet has two labels for each input / output range (e.g. 000 – 007) for this application.

Each label sheet will consecutively label up to four breakout panels from Inputs 000 through 287 and four breakout panels from Outputs 000 through 287.

If you do not receive enough labels for your particular application, contact Utah Scientifics' Technical Services at 1-800-447-7204 for additional labels.

The illustration below shows the proper application of the labels on the breakout panel.

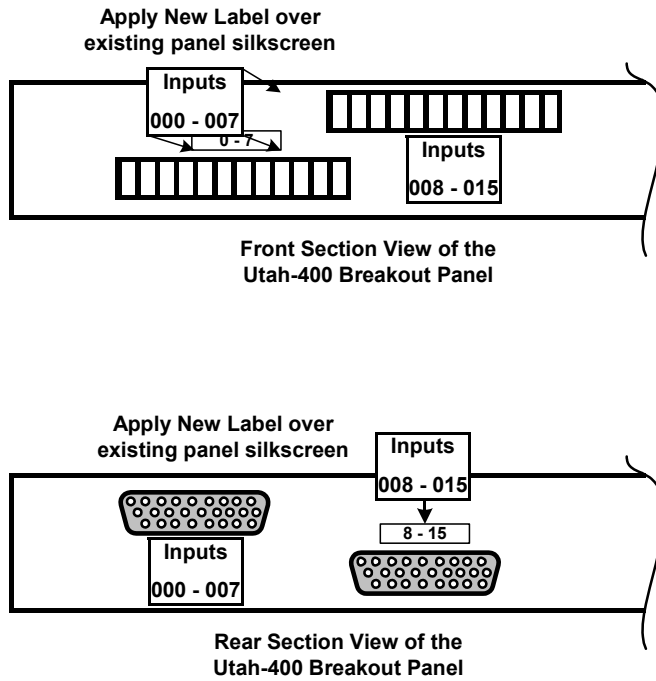

FIGURE C-3. Breakout Panel Label Application

Index

Numerics

0V 2-22
10 X 10 switching matrix 1-6
12 AWG 2-22
26-pin high-density connector 2-16
3G Input Card 4-6
3G Output Board 4-14
-48V 2-22

A

Abbreviations 1-3
Active FPGA B-4
AES Breakout Panel C-2
AES reference cabling 2-9
AES reference signal 2-8
alarm indicators
 fan 3-5
alarm specifications A-7
alarms
 system controller 5-8
analog to digital board 4-3
Audio Crosspoint board
 adjustments 4-42
 description 4-40
 LED indications 4-41
 test points 4-46
Audio Input board 4-30
Audio Output board 4-31
audio subsystem
 troubleshooting table 5-5

B

basic system operation 3-4
BNC connection (midplane) 4-27
breakaway takes 1-5
Breakout Panel C-1

C

cable connection recommendations 2-13
cable installation
 digital audio input and output 2-16
card ejectors 3-4
card removal and replacement 3-4
chassis demographics 1-8
Checking Input and Output
 debug B-10

configuration dipswitch 2-10
connector suppliers A-9
control panel
 troubleshooting table 5-9
control specifications A-6
control subsystem troubleshooting table 5-7
control system compatibility 1-10
crosspoint board fuse assembly 4-45
crosspoint card
 removal and replacement 3-4
crosspoint fuse location
 illustration 2-23
crosspoint reset button 4-43

D

data rates 1-11
DC Connectivity 2-22
DC power specifications A-2
Debug
 cable B-3
 port B-1, C-1
debug port 4-43
Definitions
 control panel 1-4
 destination 1-4
 display 1-4
 high definition 1-5
 hot swappable 1-4
 monitor 1-5
 output 1-4
 serial digital 1-5
 signal level 1-4
 source 1-4
Deluxe Output board 4-32
digital audio specifications A-4
digital video specification A-3
Digital Video to analog converter output card 4-9
dip-switch
 audio crosspoint board 4-42
dipswitch location
 crosspoint carrier board 2-10
dipswitch settings
 video crosspoint board 4-22

E

equipment installation 2-3
External PS Status B-14

F

fan service 3-5
Fiber Interface 4-17
FPGA control board 4-23
FPGA Memory Status B-6
frame boundary 2-8
frame connection
 SC-3 to Utah-400 2-6
fuse
 crosspoint board 4-45

G

Ground 2-22

H

hardware checkout 2-24
Hardware Status Display B-13
HD-output board 4-9
high definition SDI video specifications A-5

I

input backplane 2-13
input power specifications A-2
installation
 audio input and output recommendations 2-16
 video input and output 2-13
Interface board (midplane)
 general description 4-26
 part description 4-27
IO Card Information B-12
IO Information
 debug B-11

J

jumpers
 video crosspoint board 4-25

L

LED Indications
 audio crosspoint board 4-41
 Deluxe audio output board 4-33
 fiber output 4-19
 power supplies 4-29
 SD video and HD (multi-rate) output 4-10
 SD video and multi-rate input 4-3
 Time Base module 4-44
 video crosspoint board module 4-24
 video crosspoint card 4-22
level assignment

 per dipswitch selection 2-12
level dipswitch 2-10
level dipswitch settings 2-11
loop lock 4-44

M

Main Menu
 debug B-5
matrix backplane 2-13
midplane 1-8
monitor matrix function 4-27
Multi-Rate input board 4-2
Multi-Rate output board 4-9
MX Bus
 interface board 4-27
MX-Bus cable installation 2-6

O

offset dipswitch 2-10
offset dipswitch settings 2-12
output backplane 2-13

P

PGMXPT1-2 4-41
PGMXPT3-4 4-42
physical specifications A-8
pin-out
 26-pin high-density connector table 2-19
 DB-26 high-density illustrations 2-20
power connections 2-21
 illustration 2-21
Power Cord Retainer 3-9
power redundancy 2-21
power subsystem troubleshooting table 5-6
power supplies 4-29
power supply
 audio crosspoint fault indications 4-42
power supply alarms 5-6
PRIACT 4-42
PWROK 4-42

R

rack frame layout 2-4
rack frame mounting 2-3
Reclocking Input Expansion Card 4-5
Ref OK 4-44
reference signal 2-8
reference specifications A-5
regulatory specifications A-8

Index

RJ-45 connection
 midplane 4-27
Router Crosspoint Status
 debug B-7
routing switcher basics 1-5

S

sample configurations 1-12
SC-4 Control 3-2
scangage I/O 4-41
scangate active 4-33, 4-41
SD video input 4-2
SD-output board 4-8
SECACT 4-41
SGACT 4-33, 4-41
SGI-O 4-41
signal level
 definition 1-7
signal level setup 2-9
SMPTE Alarm A-6
Software verification
 debug B-6
Specifications
 alarms A-7
 connector suppliers A-9
 control A-6
 digital audio A-4
 digital video A-3
 high definition SDI video A-5
 input and DC power A-2
 physical A-8
 reference A-5
 regulatory A-8
switching matrices
 digital audio and video 1-10
switching matrix 1-6
system configurations 1-12
system controller alarms 5-8
system weight 2-2

T

Tension Clamp Connector C-4
terminal block 2-22
terminal settings
 debug port B-3
Terms 1-4
test points
 audio crosspoint card 4-46
Time Base module 4-43

troubleshooting chart 5-2
troubleshooting tables
 audio subsystem 5-5
 control panel 5-9
 control subsystem 5-7
 main 5-3
 power subsystem 5-6
 video subsystem 5-4

U

unpacking 2-2
Utah-400
 features 1-10
 standard configuration 2-17
Utah-400 routing matrix 1-8

V

Video Crosspoint board
 description 4-21
 user controls 4-22
Video crosspoint board (redundant) 4-21
video crosspoint board module
 illustration 4-23
video crosspoint LED's
 power OK 4-22
 scan data active 4-23
 voltage failure 4-22
Video crosspoint module
 jumper location 4-25
video subsystem
 troubleshooting table 5-4

W

Wire Preparation
 breakout panel C-3
wiring
 recommendations 2-18